



prince[®]

ASSEMBLY INSTRUCTIONS

FUSION PRO PT1800

TABLE TENNIS TABLE



CAUTION















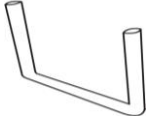
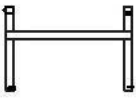

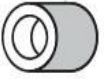

**DO NOT ASSEMBLE THIS TABLE WITHOUT READING THIS MANUAL
TO FAMILIARIZE YOURSELF WITH THE ASSEMBLY PROCESS FIRST.**

PLEASE RETAIN INSTRUCTIONS FOR FUTURE PARTS IDENTIFICATION.

TOOLS REQUIRED FOR ASSEMBLY (Not Included):

SCREW DRIVER and two ADJUSTABLE WRENCHES

PARTS IDENTIFIER and ASSEMBLY PARTS

P1	QUANTITY: 4	P2	QUANTITY: 2	P3	QUANTITY: 4	P4	QUANTITY: 2
				(2 PRE-INSTALLED) 			
Bolt, 6x55mm Hex Head		Safety Catch with Nut		Bracket, Metal		Brace, Center Leg Support	
P5	QUANTITY: 4	P6	QUANTITY: 2	P7	QUANTITY: 2	P8	QUANTITY: 4
		(PRE-INSTALLED) 		(PRE-INSTALLED) 			
Bending Linkage Support		1.25" Inner Leg		2" Outer Leg		Bolt, 6x70 mm Hex Head	
P9	QUANTITY: 8	P10	QUANTITY: 24	P11	QUANTITY: 8	P12	QUANTITY: 8
		(12 PRE-INSTALLED) 					
Lock Nut, 8mm		Screw, 4 X14mm Hex Head		Washer, 8mm		Bolt, 8 x 70mm Hex Head	
P13	QUANTITY: 8	P14	QUANTITY: 16	P15	QUANTITY: 8	P16	QUANTITY: 1
							
Bushing		Washer, 6mm		Lock Washer, 6mm		Set, Net and Post	
P17	QUANTITY: 1	P18	QUANTITY: 4	P19	QUANTITY: 2	P20	QUANTITY: 2
(PRE-INSTALLED) 		(PRE-INSTALLED) 					
Safety Strap		Corner Cap		Wheel Assembly, Non-Locking		Wheel Assembly, LOCKING	
		P21	QUANTITY: 4				
							
		Label, Fusion Pro Apron					

ASSEMBLY INSTRUCTIONS

We recommend that at least two strong adults work together to assemble this table.

The table will be assembled upside down and then turned over onto its legs.

This is a very heavy table and turning it over will require at least two strong adults.

We suggest that you use the bottom carton as a clean flat work area to protect the table.

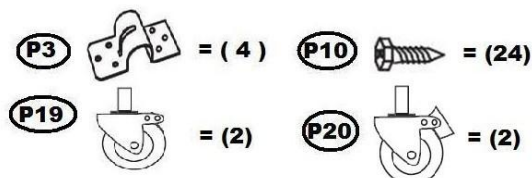
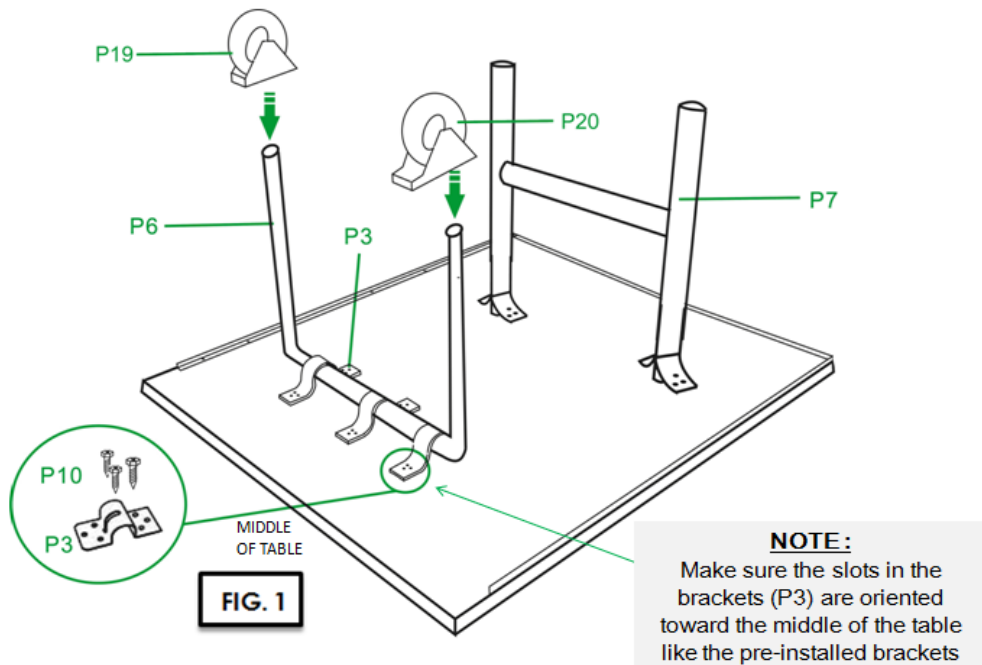

STEP 1 (FIG. 1)

- * Attach one wheel without lock (#P19) and one wheel with lock (#P20) to the Inner Leg (#6). Please repeat the same steps for the other Inner Legs. See Fig.1 above.

NOTE: Make sure one of each wheel w/o lock (#P19) and one wheel with lock(#P20) are attached to each Inner Leg.

- * Make sure one Pre-installed Metal Bracket (#P3) is attached over per Inner Leg (#P6).
- * Attached the two Metal Brackets (#P3) over the ends of the Inner Leg (#P6) using six Screws (#P10) per bracket. (as shown on Fig. 1)

NOTE: Make sure the slots in the brackets are facing the center.

- * Repeat the above steps for the other table half.

ASSEMBLY INSTRUCTIONS (continued)

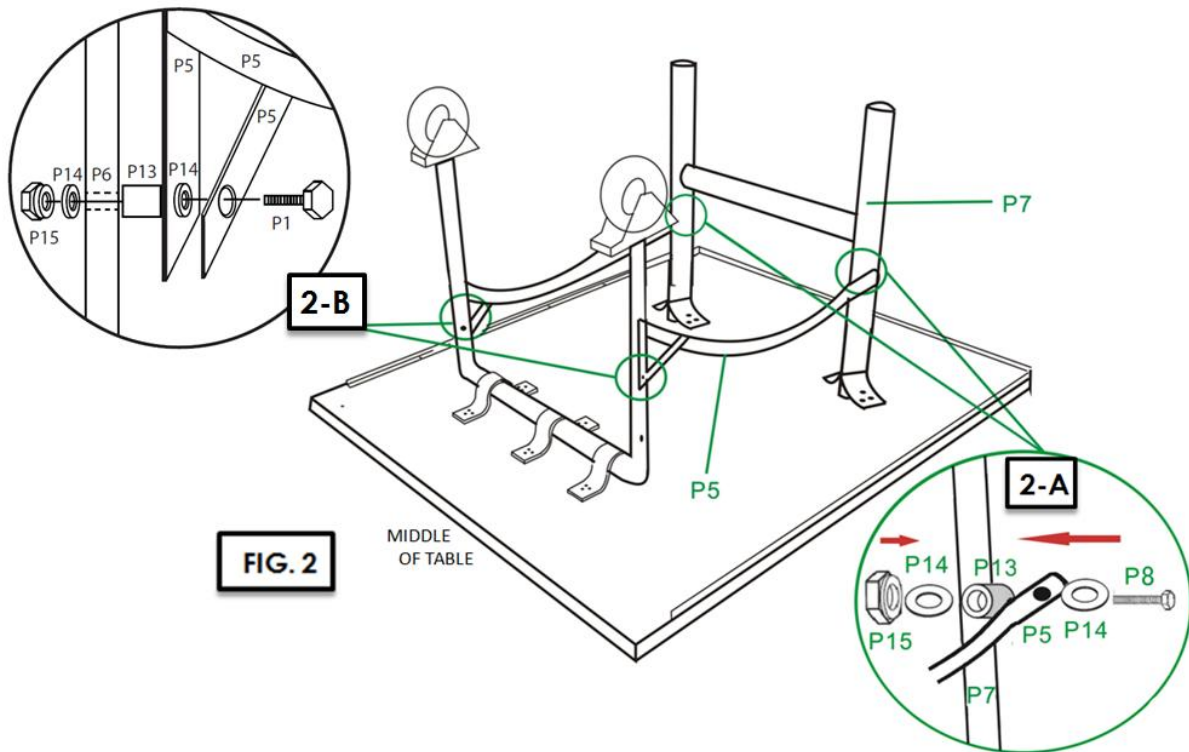
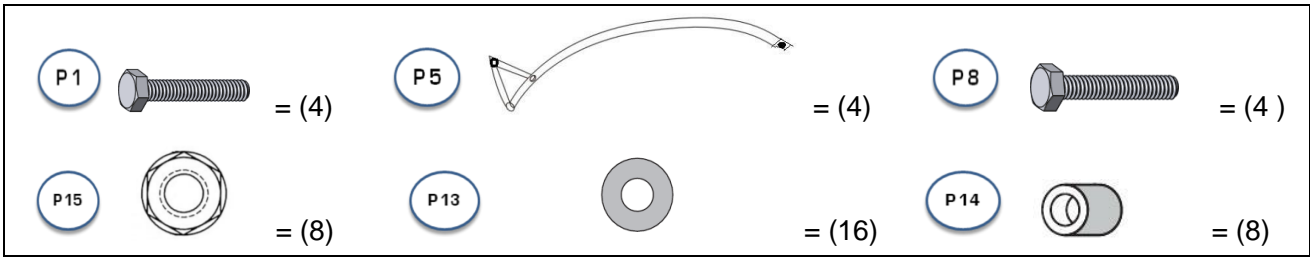

STEP 2 (FIG. 2)

- Attach one end of the Bending Linkage Support (#P5) to the Outer Leg (#P7) with one Bolt (#P8), one Bushing (#P13), two Washers (#P14) and one Locking Nut (#P15) per Outer Leg. See 2-A.
- Then attach the other end of the Bending Linkage Support (#P5) to the Inner Leg (#P6) using one Bolt (#P1), one Bushing (#P13), two Washers (#P14) and one Locking Nut (#P15) per Tube. See 2-B.
- Repeat the same assembly for the other Bending Linkage Supports.
- Attaching the Bending Linkage Support (#P5) to the Inner Leg might seem a little complicated so we have prepared a video that demonstrates the assembly process at each leg. You may access the video by scanning the “QR” code below with your smartphone or visiting the DMI Sports link and selecting the “Prince Fusion Table Assembly Instructions”



www.youtube.com/dmisports

ASSEMBLY INSTRUCTIONS (continued)

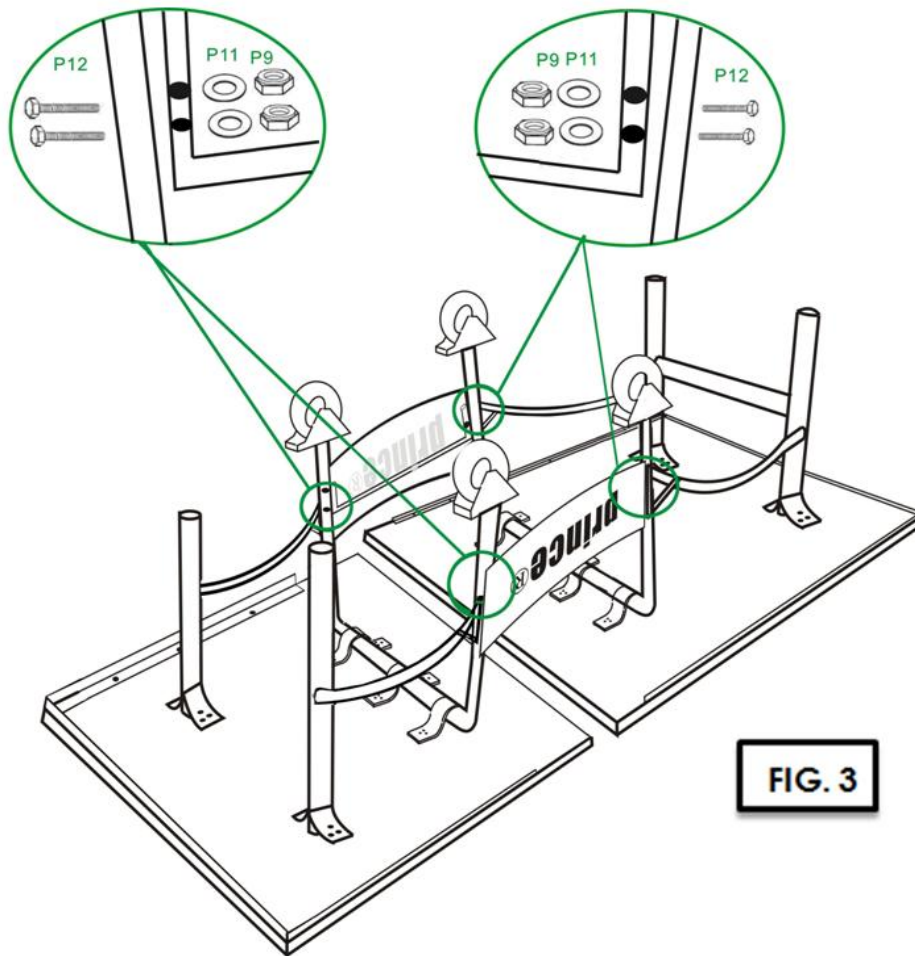
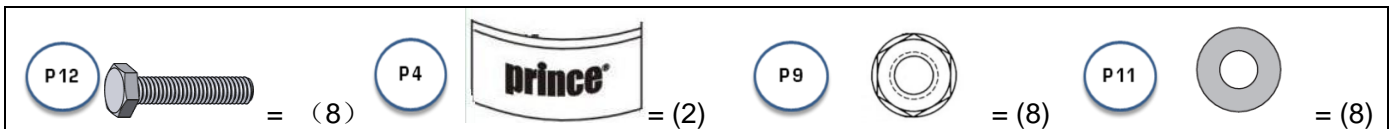

FIG. 3



STEP 3 (FIG. 3)

* With the logo upside-down, attach one Leg Metal Spreader (#P4) to the Inner Leg (#P6) with two Bolts (#P12), two Washers (#P11) and two Nuts (#P9) per Spreader. See Fig. 3.

Repeat the same assembly for other side.

- * Before turning the table over, make sure to push the Inner Leg (#P6) towards the player end of the table in order to engage the table stop.
- * At least two strong adults are required to turn this table over.
- * Do not let the full weight of table rest on its side or its legs, or this may damage the table.
- * One person should stand at each end of the table and turn the table over completely so that it rests on its legs.

ASSEMBLY INSTRUCTIONS (continued)



STEP 4 (FIG. 4)

- * Attach one Safety Catch (#P2) to the Inner Leg (#P6) with one Nut (attached to the Safety Catch) per side. Attach the Fusion Pro label to the end of the side apron. See Fig.4
- * Repeat the above step for the other side.

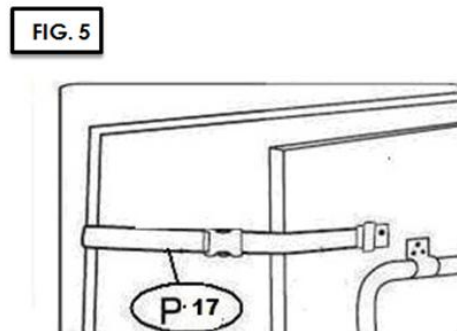

This is a very heavy table by design. **An adult should always raise and lower table sides for storing.**

To close the table, raise the end of the table without the net and posts. The end legs should collapse toward the underside of the table (but will not lie flat). Continue raising the end until table surface is vertical and safety catch is engaged.

Use safety strap to secure.

To open the table, release the safety strap and raise the red safety catch. With the safety catch up the table top is now ready to be lowered.

This table is for INDOOR USE only.



RECOMMENDATION OF USE AND PRECAUTIONS

Anyone using or handling this table tennis table must always follow the illustrations and the operation instructions.

1. **Handling the table, (assembly, open, close, or to store) should always be done by two adults to prevent accident or injury.**
2. Be sure that no persons, pets or objects are in the way of the table when opening or closing.
3. Do not put heavy objects on the table.
4. Do not sit on the table.
5. Do not clean the table with solvents or any other aggressive product because it could damage the paint finish.
6. Do not use sharp objects on the table.
7. If the table is used for purposes other than playing table tennis, cover the surface to prevent damage.
8. The functioning and storage of this product should always be supervised by an adult.
9. Do not store or handle the table on an unstable floor surface.
10. If safety device malfunction occurs, secure table top until the problem is solved.
11. To extend the life of this table, (outdoor table or indoor table) protect it from moisture or severe climate changes.

CARE AND MAINTENANCE

Cleaning your table

Use a soft damp (not wet) cloth only. **DO NOT USE ANY CHEMICALS OR ABRASIVE OR CLEANING PRODUCTS** on the playing surface.

Maintenance of your table

All moving parts must be periodically oiled including the pivot points. This will insure ease of use and safety of your table. Once or twice per year or when folding and unfolding action is not smooth.

This table must be stored indoors to avoid damage to the surface. Dampness and temperature changes can cause wood play surface to warp, swell or blister.

Please visit:

<http://www.dmisports.com/table-tennis/>

for information on the full line of Prince table tennis accessories.

DMI Sports, Inc.

Fort Washington, PA USA

www.dmisports.com