

2014
Owner's Manual



Members of the ATA

817 Maxwell Avenue
Evansville, IN 47711

800 - 694 - 9494 • fax 812 - 467 - 1245

www.BearArcheryProducts.com

Contents

Important Bow Information	01-03
Archery Safety & Warnings	04-05
Bow Diagrams	06-08
Care & Maintenance	09-10
Bow/Cam Adjustments	11-29
Initial Bow Setup	30-34
Arrow Selection Information	35
Warranties	36-37

Record important bow information here and keep
for future reference.

Model

Weight Range

Draw Length

String Length

Cable Length

Purchased From

Date Purchase

Serial Number

Congratulations! Your new Bear Archery compound bow is the finest available. It has been engineered for accuracy, long life, and built with quality and pride. No other bow delivers a higher performance to value ratio than a Bear. We know how much you are going to enjoy your new bow. For this reason, we ask you read the Care and Maintenance section carefully to learn how easy it is to maintain the quality, performance, and level of satisfaction you expect from a Bear Archery product.

ENJOY YOUR NEW BOW!

IMPORTANT LIMB INFORMATION

Your new Bear Archery bow uses the latest technology in limb design. This creates a limb capable of storing optimal amounts of energy unlike any other bow in the industry. For that reason, the use of limb mounted accessories such as vibration dampeners must be restricted. These particular accessories **MUST NOT BE** mounted more than 2 inches from the limb pockets. Mounting limb accessories more than 2 inches away from the pockets, particularly clamping type accessories, can potentially damage the limbs and void the warranty. See the illustration below.

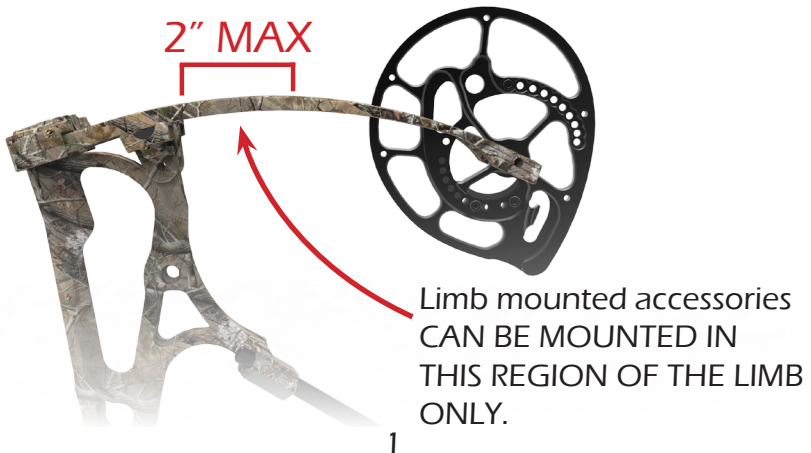

IMPORTANT PRESS INFORMATION

Due to the design of your Bear Archery bow limbs, it is of the utmost importance that your bow ONLY BE PRESSED IN PROPER BOW PRESSES. Traditional style presses that use rollers to apply pressure only to the mid section of the limbs CANNOT BE USED. Only presses that are capable of applying pressure to the last 2" of the limbs should be utilized, as illustrated below

NOTE

Limb bolts MUST be backed out 3 complete turns prior to pressing a bow equipped with flare quad limbs and 4 complete turns for bows equipped with max pre-load quad limbs.

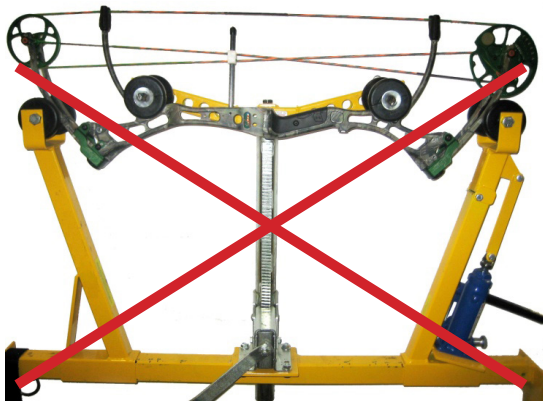

DO NOT USE THIS STYLE BOW PRESS

APPROVED BOW PRESSES

For the most up to date and accurate list, please visit your local Bear Archery dealer or www.BearArcheryProducts.com

WARNING

Failure to adhere to this list of presses can result in immediate failure of the limbs, possible injury and void the manufacturer's warranty.

IMPORTANT PRESS INFORMATION

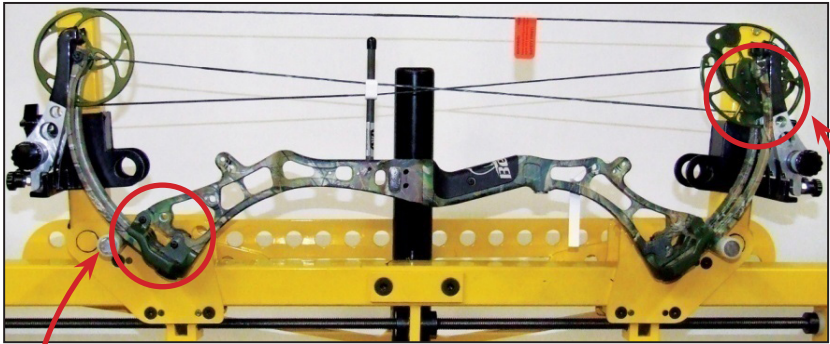

Certain bow models require the use of fixed stops to prevent the press forces from pushing the bow out of the bottom of the press.

Bow press **MUST** only be applied to the outer 2" of the limb tips.

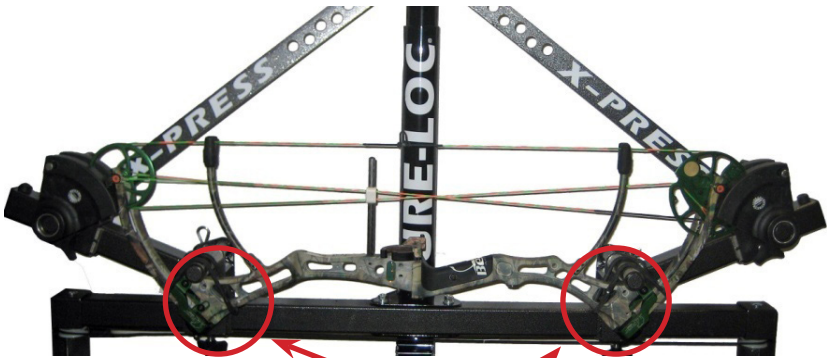

Press should be capable of adjusting to the riser's full length.

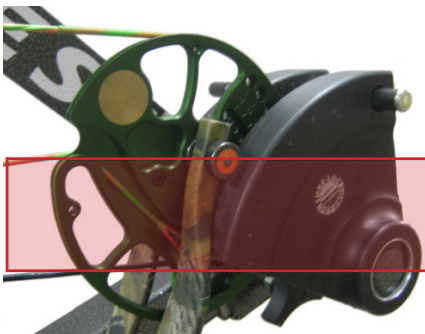

Press must **ONLY** apply pressure to the limbs in this area.

SAFETY FIRST

Before using this equipment, read and follow these manufacturer's instructions carefully. If you have any questions, contact the manufacturer or a qualified dealer.

WARNING

- Dry-firing a bow severely reduces the life expectancy of the bow and may cause immediate damage to the bow resulting in injury to yourself or others. Never dry-fire your bow! Never pull back and release the bowstring without an arrow attached to the string. Your bow is designed to transfer energy to a properly weighted arrow.

- Shooting underweight arrows has the same effect as dry-firing a bow and may cause serious injury. Use the proper arrow for you and your bow. If you are unsure about your arrow choice, contact your local Bear Archery dealer or an arrow manufacturer.

- Do not use wooden or fiberglass arrows. They are not designed for use with this compound bow and may cause serious injury. Use the proper arrow for you and your bow. If you are unsure about your arrow choice, contact your archery dealer or an arrow manufacturer.

- Inspect your arrows and nocks regularly. Immediately discard any dented, split, splintered or otherwise damaged arrows and replace cracked or broken nocks.

- Do not draw your bow beyond its maximum draw length as damage to the limbs, cables and strings could occur.

- The use of safety glasses is recommended with any archery product.

SAFETY FIRST

Targets and Hunting Safety

- Be sure of your target. Bow hunters often wear camouflage and are difficult to identify.
- Never aim at anything you don't intend to shoot.
- Never point or aim a drawn bow at another person.
- Never draw or shoot when anyone is between you and your target.
- Never shoot at a target or object unless you are sure that it can stop your arrows.
- Make sure the area behind and around your target is clear.
- Before shooting, be sure that no part of the bow will strike any tree branches or other obstacles.
- Never shoot arrows straight up in the air or in any direction where you might destroy property or endanger life.

Pre-shooting checklist

Are these items in good condition?

Properly installed? In working order?

___ Cables

___ Sight

___ String

___ Arrow Rest

___ String Serving

___ Arrow Nocks

___ Loop/Nock set

___ Arrow Shafts

___ Cable Slide

___ Set Screws

BOW DIAGRAMS

Understanding your bow and its component parts will add to your archery enjoyment. Although bows differ in performance and features, these photos represent the components available in various combinations on most models. Being familiar with this information will help you with the instructions throughout this manual. Also, you can refer to these photos when ordering parts or making technical inquiries.

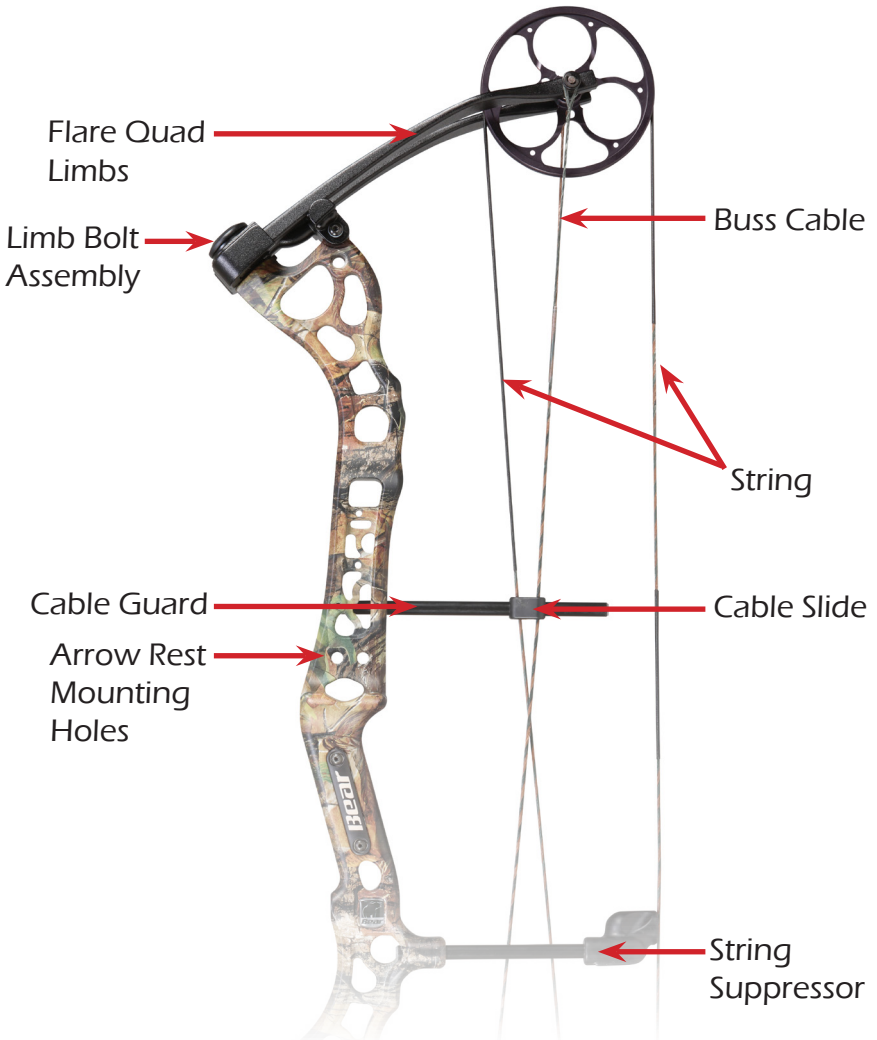

BOW DIAGRAMS

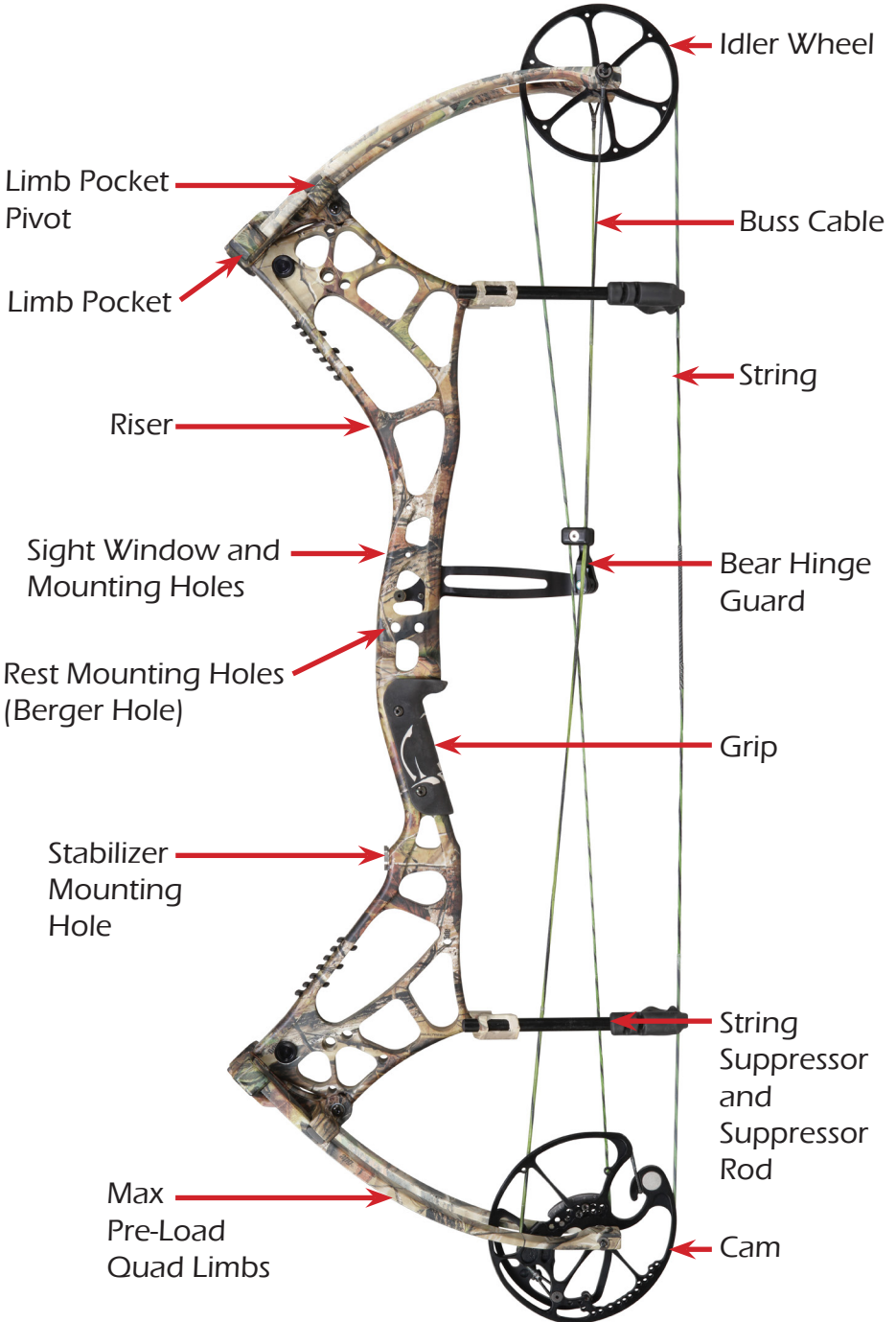

Single Cam Bow
7

BOW DIAGRAMS

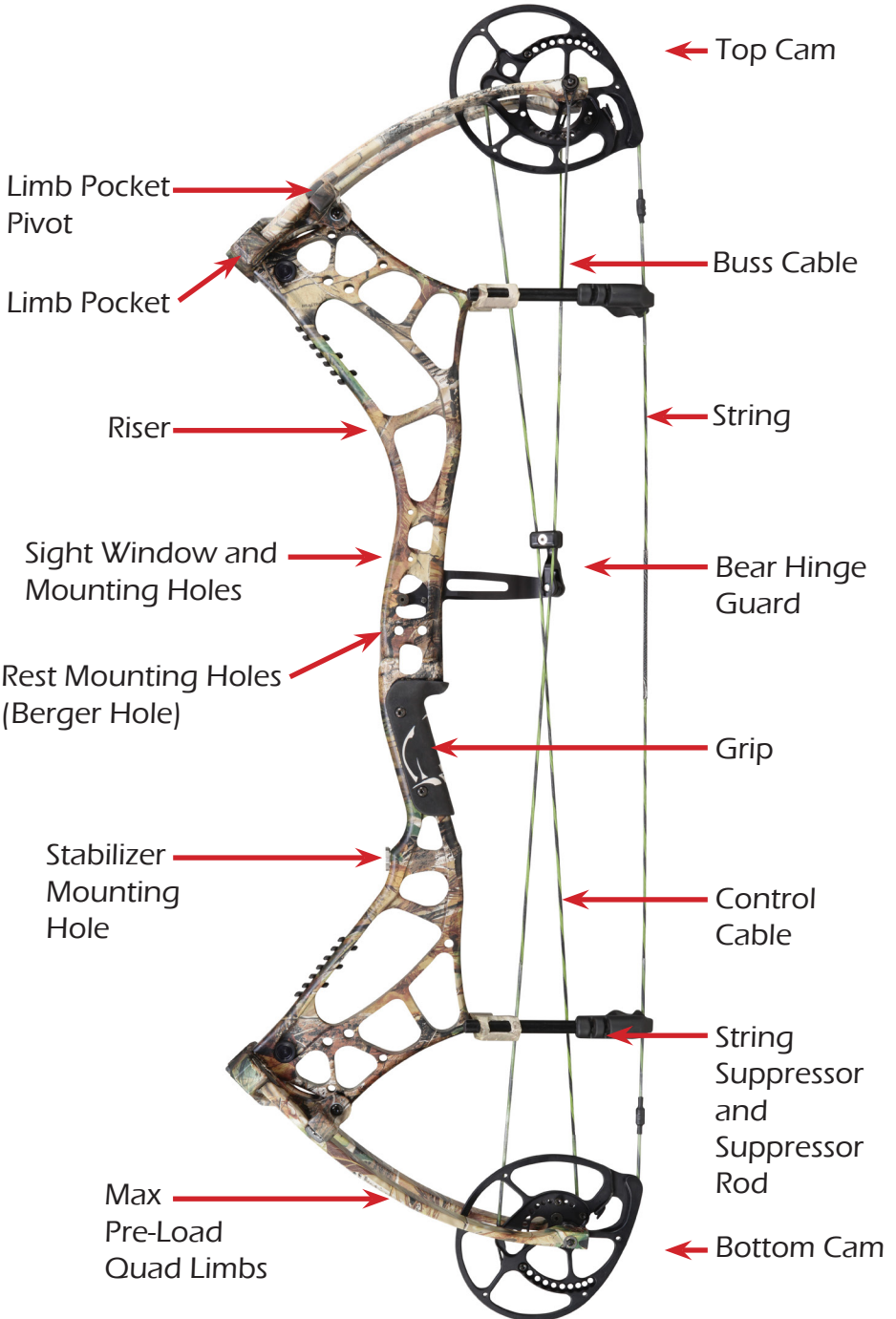

Hybrid Cam Bow

CARE AND MAINTENANCE

With proper care and a minimum amount of routine maintenance, your bow will be kept in top condition. However, it is still important to carefully inspect your bow on a regular basis.

Cleaning

Your bow should be kept clean of dust, mud and grime. Use a damp soft cotton cloth to remove dirt and moisture. Do not use solvents such as acetone or mineral spirits as they may damage the finish.

Storage and Transportation

Avoid exposing your bow to temperatures over 125 degrees. Excessive heat may damage your bow. Do not leave your bow in your vehicle on a hot sunny day or store in a hot attic or other hot enclosed area. Clean your bow thoroughly after each use. Never put your bow away wet or store it in a damp place. Lightly oil all steel parts (axles, mounting screws) to prevent rust. You can relax the limbs if storing for more than a year. Follow the instructions under Peak Draw Weight Adjustment in the bow adjustment section.

Bow Presses

Use only APPROVED bow presses. Older style “single-pull” bow presses that contact the bow only in the grip area can result in bent or broken risers.

See page 4 and/or www.BearArcheryProducts.com for additional bow press information.

CARE AND MAINTENANCE

Lubrication

Your Bear Archery compound bow requires very little lubrication. Wipe the cable guard periodically with a dry cloth to keep the cable slide running smoothly and free of dust. Cam and idler wheel bearings do not require lubrication. If other lubrication is necessary, use white lithium grease or Teflon lubricants. Avoid excessive lubrication of any item, as this can attract dirt. On hunting bows, avoid lubricants with obvious odors.

String and Cable Maintenance

Regularly apply a high quality bowstring wax to your string and cable system. Regular waxing protects your cables and strings from abrasion, wear and separation. Smear the wax into position. Then, rub it gently with your fingers or a soft piece of leather to work the wax into the strands. Replace frayed or worn bowstrings and cables immediately.

Bear Archery strongly recommends replacing the bowstring and cable annually. Please visit your local Bear Archery dealer for assistance.

BOW ADJUSTMENTS

Peak Draw Weight Adjustment

Bear Archery bows have an approximate 10 pound peak weight adjustment range.

Using a hex wrench, turn the limb bolts clockwise to increase peak weight and counter-clockwise to reduce peak weight. Bow weight will increase or decrease approximately two to four pounds per turn. **IMPORTANT** Both limb bolts must be adjusted equally. Likewise, do not turn one limb bolt more than two turns ahead of the other when making adjustments. Finally, limb bolts must never be backed out more than the specified number of full turns on bows that are equipped with max pre-load quad limbs. Also, do not back out the limb bolts more than the specified number of full turns for bows equipped with flare quad limbs unless otherwise noted.

BOW ADJUSTMENTS CONTINUED



Limb Bolt Adjustment

Bows	Max Turns
Agenda 6.....	4
Agenda 7.....	4
Anarchy HC.....	4
Apprentice 3.....	6
Attitude.....	4
Authority	4
Domain.....	4
Effect	4
Empire.....	4
Finesse.....	4
Method	4
Motive 6.....	4
Motive 7	4
Rumor.....	4
Venue	4
Outbreak	8

CAM ADJUSTMENTS

- Adjusting Draw Length - Synchronized Hybrid Cam System

H13 Cam

Draw Lengths (Inches)						
Module Setting	Agenda 6	Agenda 7	Effect	Method	Motive 6	Motive 7
5.5	25.5	26.5	27	26.5	25.5	26.5
6	26	27	27.5	27	26	27
6.5	26.5	27.5	28	27.5	26.5	27.5
7	27	28	28.5	28	27	28
7.5	27.5	28.5	29	28.5	27.5	28.5
8	28	29	29.5	29	28	29
8.5	28.5	29.5	30	29.5	28.5	29.5
9	29	30	30.5	30	29	30
9.5	29.5	30.5	31	30.5	29.5	30.5
10	30	31	31.5	31	30	31

'A' Cam

Draw Length (Inches)	
Module Setting	Anarchy HC
6.5	26.5
7	27
7.5	27.5
8	28
8.5	28.5
9	29
9.5	29.5
10	30
10.5	30.5
11	31
11.5	31.5

FH2 Cam

Draw Length (Inches)	
Module Setting	Rumor
3.5	23.5
4	24
4.5	24.5
5	25
5.5	25.5
6	26
6.5	26.5
7	27

CAM ADJUSTMENTS

Synchronized Hybrid Cam System

The Synchronized Hybrid cam has a rotating module for draw length adjustment. All draw length adjustments can be made without the use of a bow press. Draw length changes are made by simply rotating the modules to the desired position and moving the draw stop. To change draw length, remove the socket head cap screws from the top and bottom modules, rotate the modules to the desired positions (line up the indicator mark on the cam with the correct draw length indicator mark on the module), making sure to align the top and bottom to the same setting, and reapply the screws. Next, remove the draw stop on both the top and bottom cam and remount it in the corresponding stop locations to the draw length you selected. Such module draw length adjustments will not affect peak draw weight or timing. Modules are right and left hand specific and top and bottom specific.

In order for the Synchronized Hybrid cam system to operate at maximum efficiency the timing needs to be set correctly. This means that the top and bottom cams roll over and hit their respective draw stops at the same time. The cam timing is set during assembly at the factory, but once the bow is broken in, or if you change strings/cables it is possible that the cam timing will need to be checked.

If the cam system is out of time and the top stop hits before the bottom stop, add twists into the control cable until both stops hit at the same time. If the cam system is out of time, and the bottom stop hits before the top stop, take twists out of the control cable until both stops hit at the same time. The high quality string materials used in your Bear Bow will exhibit very little stretch and should maintain proper timing for extended periods under normal use.

Cam Adjustments

'H13' Synchronized Hybrid Cam System

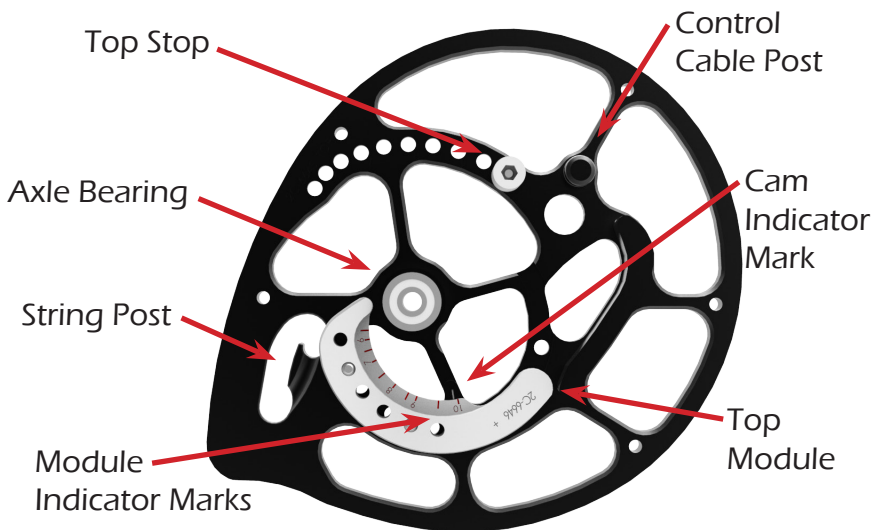

TOP CAM - Front View

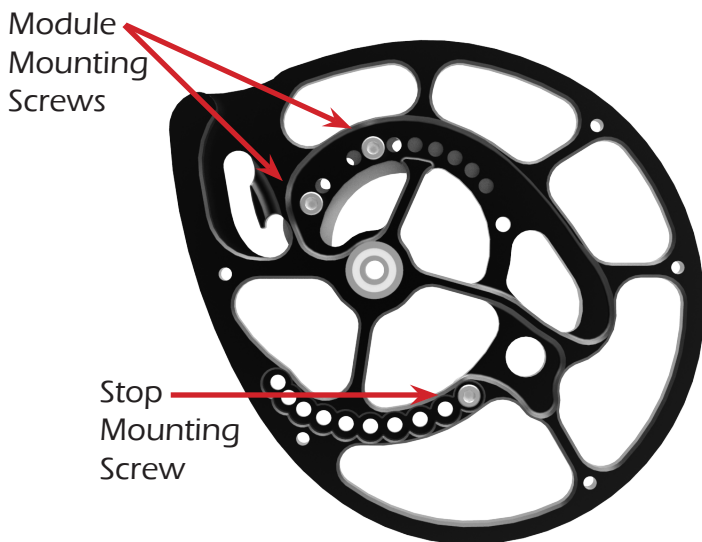

TOP CAM - Back View

Cam Adjustments

'H13' Synchronized Hybrid Cam System

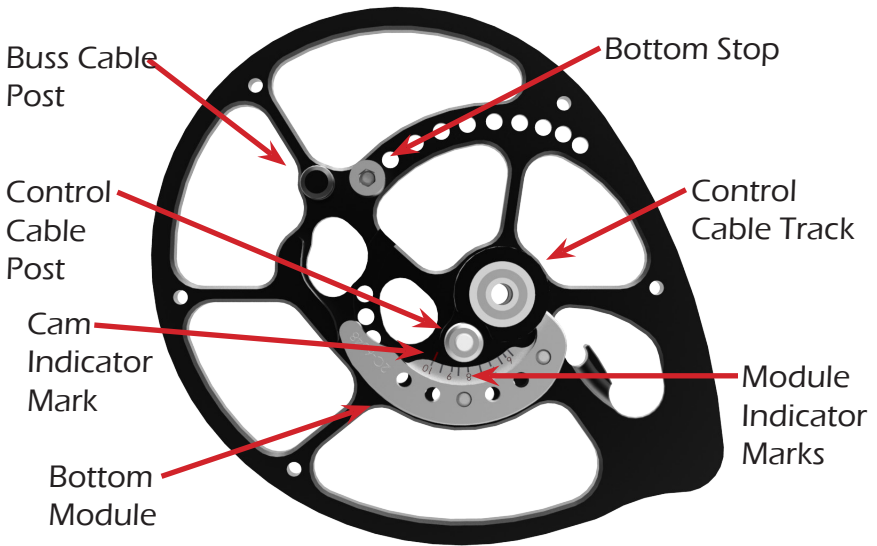

BOTTOM CAM - Front View

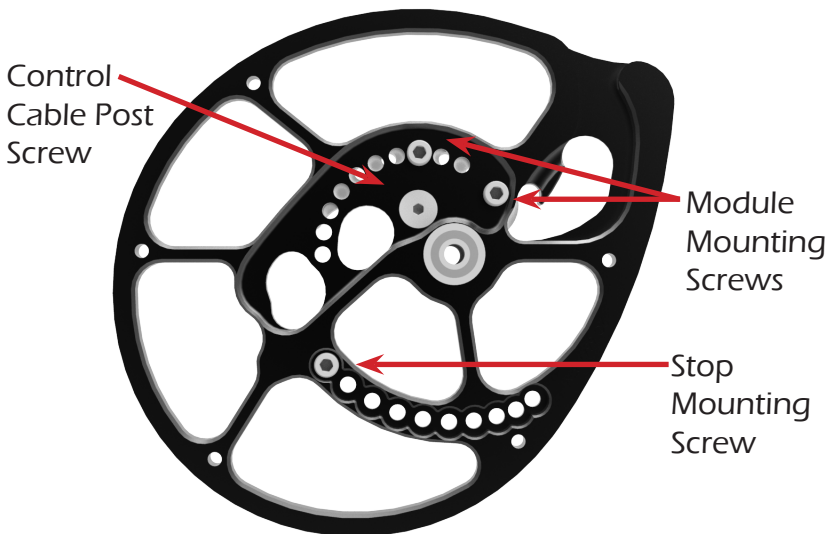

BOTTOM CAM - Back View

Cam Adjustments

'A' Synchronized Hybrid Cam System

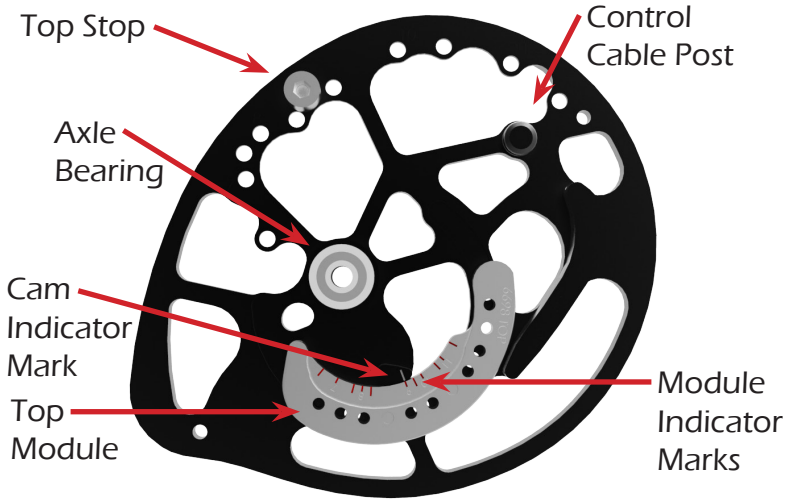

TOP CAM - Back View

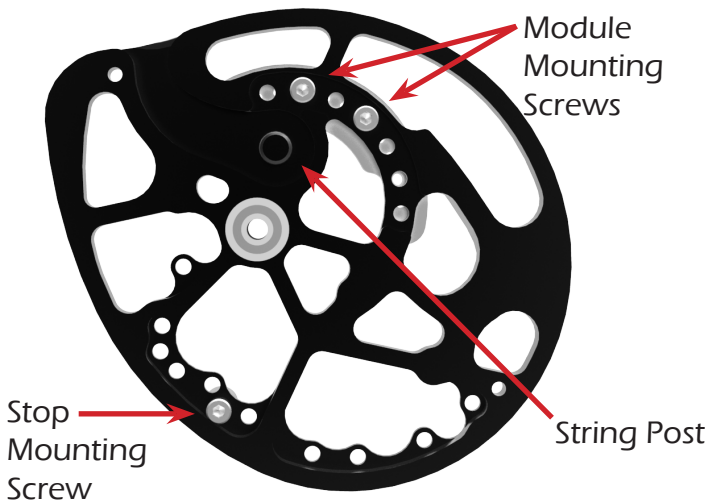

TOP CAM - Back View

Cam Adjustments

'A' Synchronized Hybrid Cam System

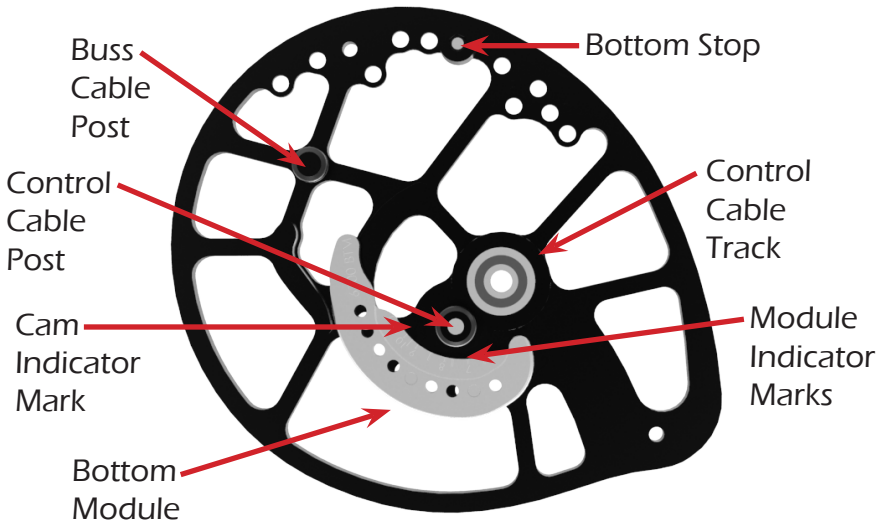

BOTTOM CAM - Front View

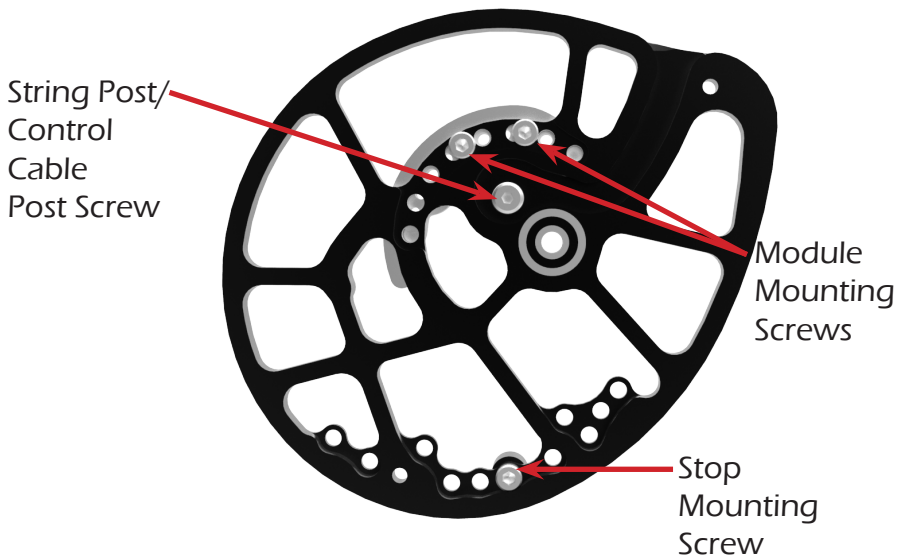

BOTTOM CAM - Back View

Cam Adjustments

'FH2' Synchronized Hybrid Cam System

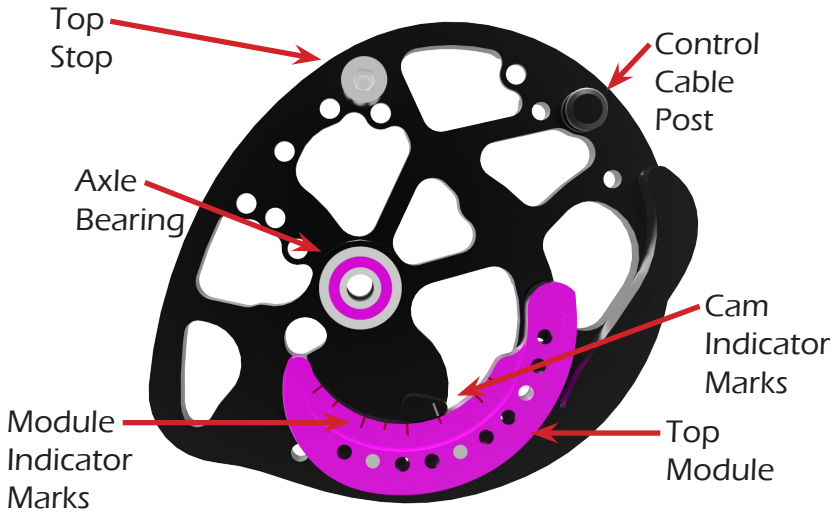

TOP CAM - Front View

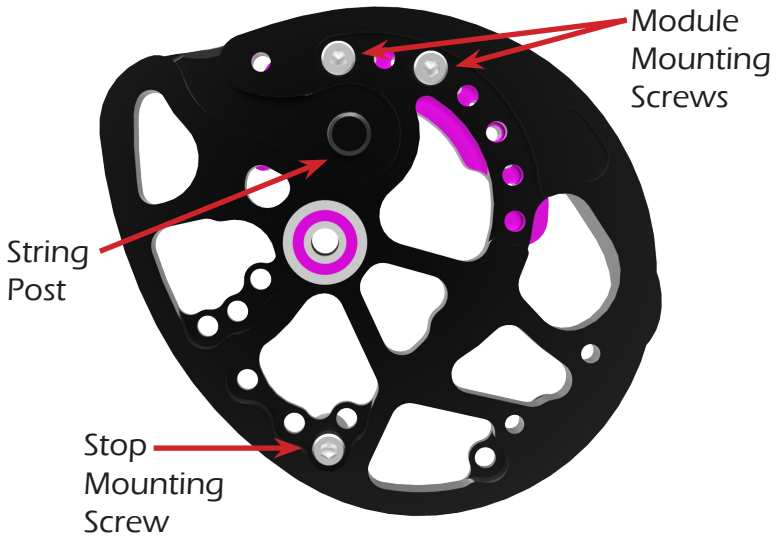

TOP CAM - Back View

Cam Adjustments

'FH2' Synchronized Hybrid Cam System

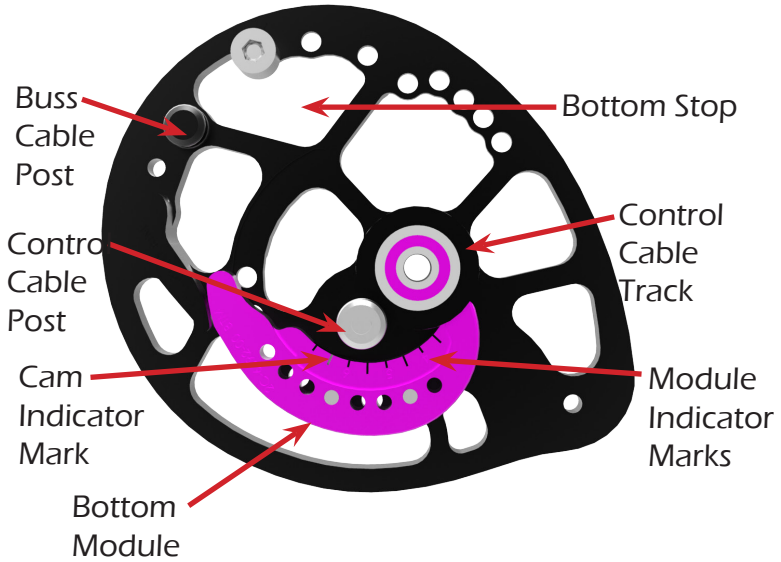

BOTTOM CAM - Front View

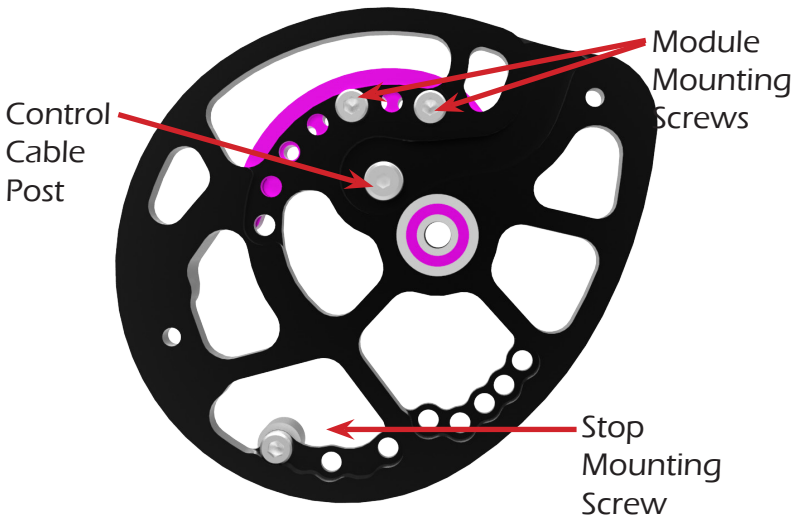

BOTTOM CAM - Back View

CAM ADJUSTMENTS

- Adjusting Draw Length - Dual Cam Systems

G3 Growth Cam

Draw Length (Inches)	
Module Setting	Apprentice III
15	15
16	16
17	17
18	18
19	19
20	20
21	21
22	22
23	23
24	24
25	25
26	26
27	27

Outbreak Cam

Draw Length (Inches)	
Module Setting	Outbreak
16	16
17	17
18	18
19	19
20	20
21	21
22	22
23	23
24	24
25	25
26	26
27	27
28	28
29	29
30	30

Draw Weight vs Draw Length

Draw Length	Draw Length [in] vs Draw Weight [lbs]					
	Limb Bolt Bottomed			Limb Bolt Fully Backed Out		
	60 lb Apprentice 2	50 lb Apprentice 2	Outbreak	60 lb Apprentice 2 (6 turns)	50 lb Apprentice 2 (6 turns)	Outbreak (8 turns)
15	39.5-43.5	30-34	-	21-25	14.5-18.5	-
16	39.5-43.5	30-34	28-32	21-25	14.5-18.5	16-20
17	39.5-43.5	30-34	28.5-32.5	21-25	14.5-18.5	16-20
18	40-44	31.5-35.5	32.5-36.5	23-27	16-20	19-23
19	43.5-47.5	34-38	37-41	24.5-28.5	17.5-21.5	21.5-25.5
20	45.5-49.5	36.5-40.5	41-45	26-30	20-24	24.5-28.5
21	48-52	39.5-43.5	45-49	28-32	21.5-25.5	27-31
22	50-54	40.5-44.5	49.5-53.5	29.5-33.5	23-27	30-34
23	51.5-55.5	42.5-46.5	53-57	31-35	24.5-28.5	32.5-36.5
24	53-57	44-48	56.5-60.5	32.5-36.5	26-30	35-39
25	55-59	46-50	59.5-63.5	34.5-38.5	28-32	37.5-41.5
26	56.5-60.5	47.5-51.5	62.5-66.5	37-41	30.5-34.5	39.5-43.5
27	60-64	50-54	64.5-68.5	40.5-44.5	34-38	41.5-45.5
28	-	-	66.5-70.5	-	-	43.5-47.5
29	-	-	68.5-72.5	-	-	45.5-49.5
30	-	-	70-74	-	-	48-52

CAM ADJUSTMENTS

- Adjusting Draw Length - Dual Cam Systems

The Outbreak and G3 Growth cam equipped bows can be configured to provide a draw length from 16"-30" for the Outbreak, and 15"-27" in 1" intervals. No bow press is required to adjust the multidraw cam system. To adjust the draw length, first remove the socket head cap screw located in the rotating module. Next rotate the module to the desired draw length and reinstall the screw in the corresponding hole. It may be necessary to pull the cable away from the module to provide clearance for the module to rotate, see the picture below. Next perform the same operation on the opposite cam. Be sure that both the top and bottom cams are set to the same draw length position. The adjustable cam operates on a sliding poundage scale where an increase in draw length also provides an increase in peak draw weight. This allows the bow to grow with the archer. The chart on the previous page shows the peak draw weight at each draw length for the Apprentice and Outbreak bows.

Cam Adjustments 'G3 Growth' Dual Cam System

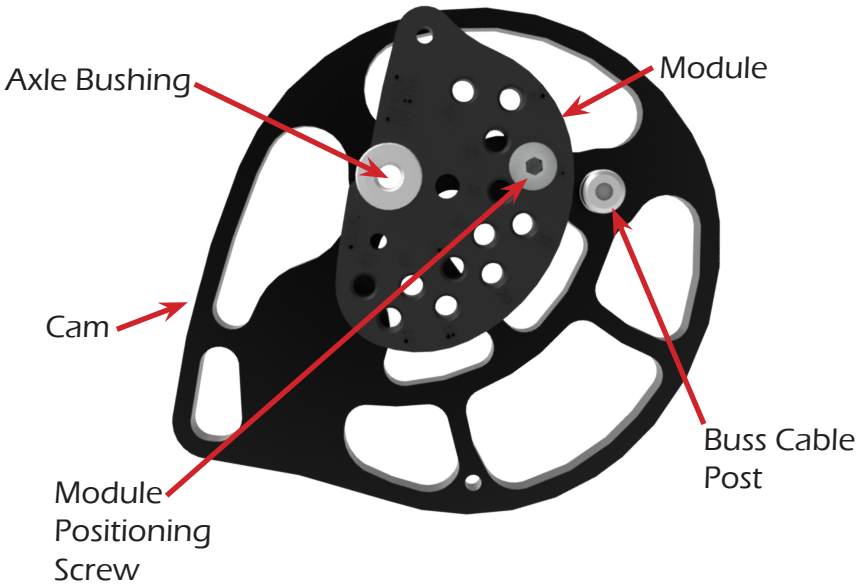

CAM - Front View

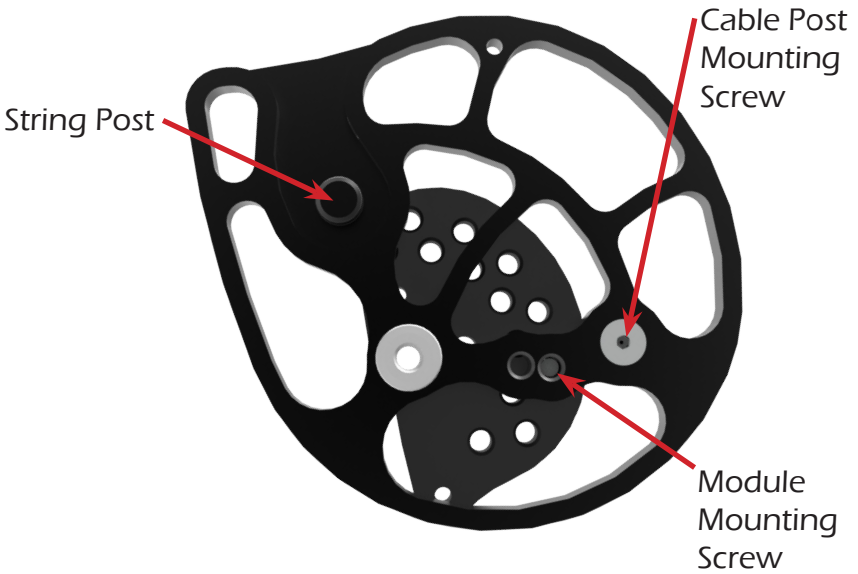

CAM - Back View

Cam Adjustments

Ourbreak Dual Cam System

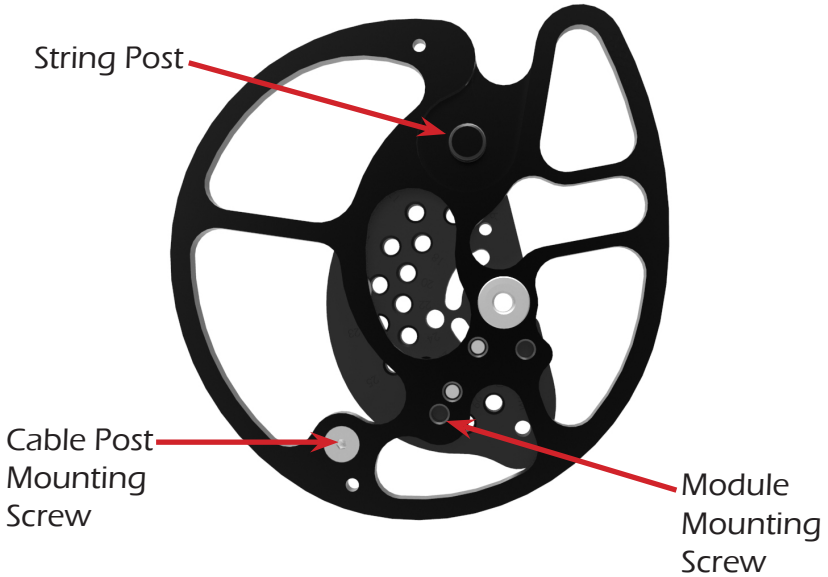

CAM - Front View

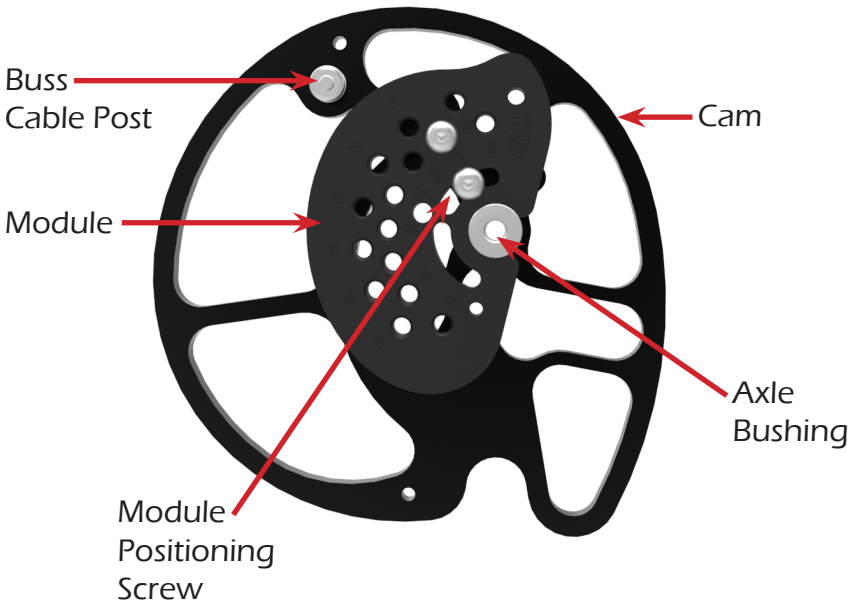

CAM - Back View

CAM ADJUSTMENTS

- Adjusting Draw Length - Rotating Module System

S13 Cam / EZ3 / E3

Draw Lengths (Inches)					
Module Setting	Domain	Venue	Empire	Attitude	Authority
4	*	24	24	25	24.5
4.5	*	24.5	24.5	25.5	25
5	*	25	25	26	25.5
5.5	*	25.5	25.5	26.5	26
6	26	26	26	27	26.5
6.5	26.5	26.5	26.5	27.5	27
7	27	27	27	28	27.5
7.5	27.5	27.5	27.5	28.5	28
8	28	28	28	29	28.5
8.5	28.5	28.5	28.5	29.5	29
9	29	29	29	30	29.5
9.5	29.5	29.5	29.5	30.5	30
10	30	30	30	31	30.5
10.5	30.5	30.5	30.5	31.5	31
11	31	31	31	32	31.5

'FH1' Cam

Draw Length (Inches)	
Module Setting	Finesse
5	23
5.5	23.5
6	24
6.5	24.5
7	25
7.5	25.5
8	26
8.5	26.5
9	27
9.5	27.5
10	28

CAM ADJUSTMENTS

- Adjusting Draw Length - Rotating Module System

The rotating module cam system allows the bow to be adjusted to all of its draw length positions without the use of separate individual modules and does not require a bow press for draw length adjustments at 1/2" increments. Draw length changes are made by first removing the socket head cap screws that secure the rotating module unit. Next, rotate the module until the desired module draw length module tick mark is lined up with the cam tick mark, and reinstall the screws in the corresponding holes. Such draw length adjustments will not affect peak draw weight. When the rotating module unit is repositioned to adjust draw length, the draw stop must also be moved to the corresponding setting marked on the cam.

Cam Adjustments 'S13' Rotating Module System

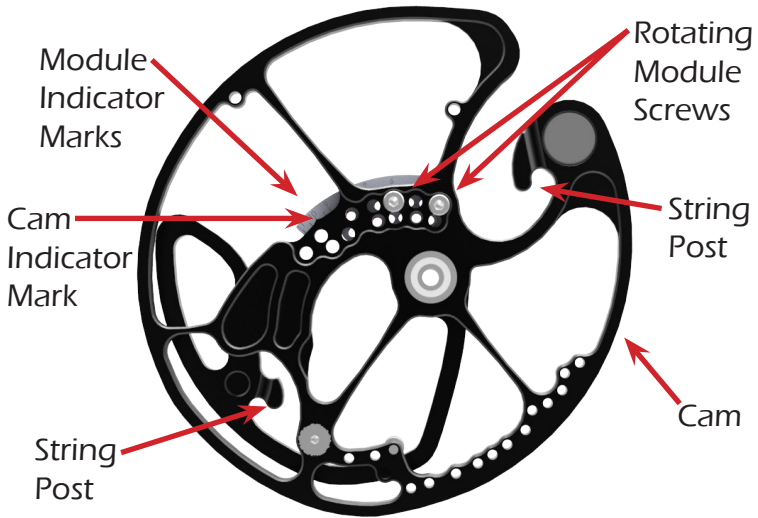

Front View



Back View

Cam Adjustments 'EZ3' Rotating Module System

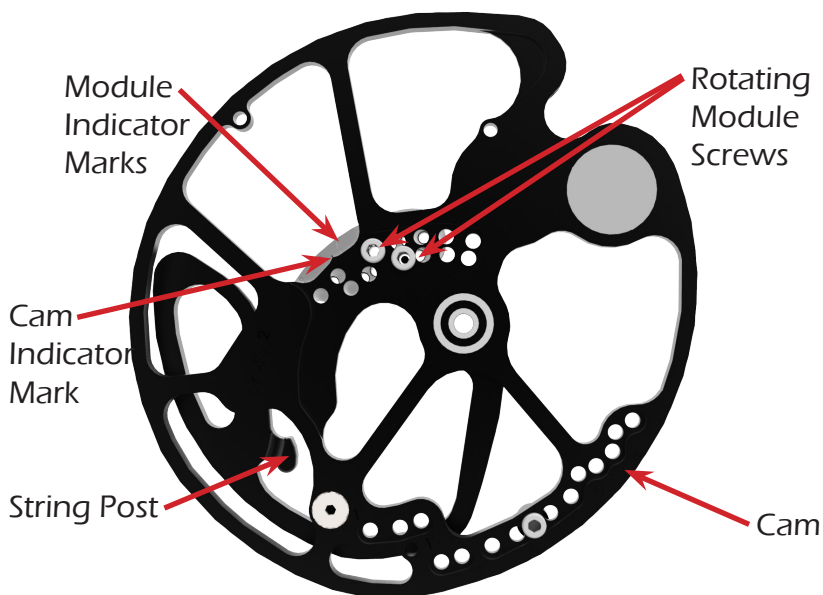

Front View

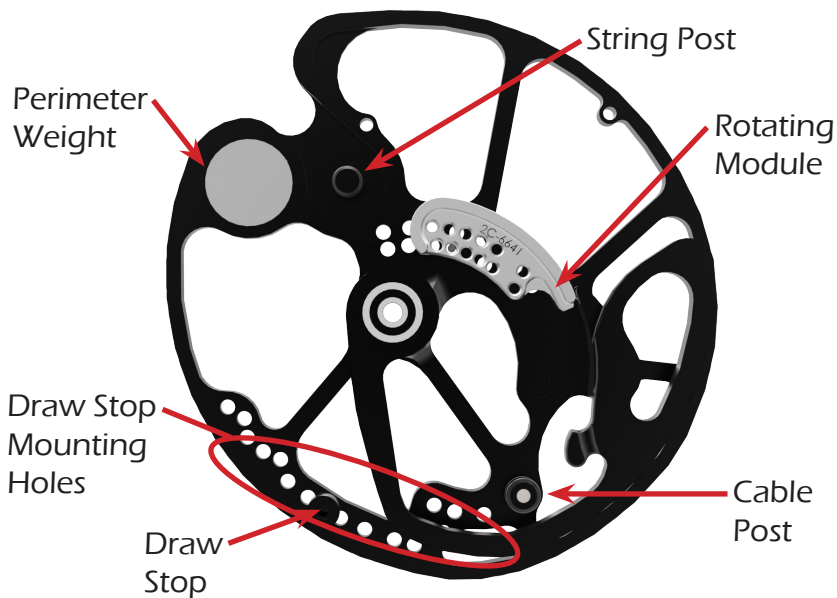

Back View

Cam Adjustments 'FH1' Rotating Module System

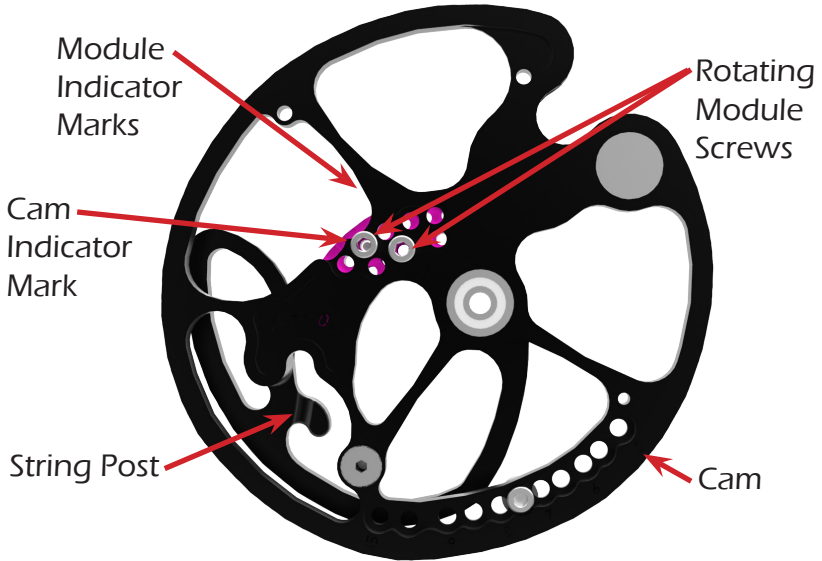

TOP CAM - Front View

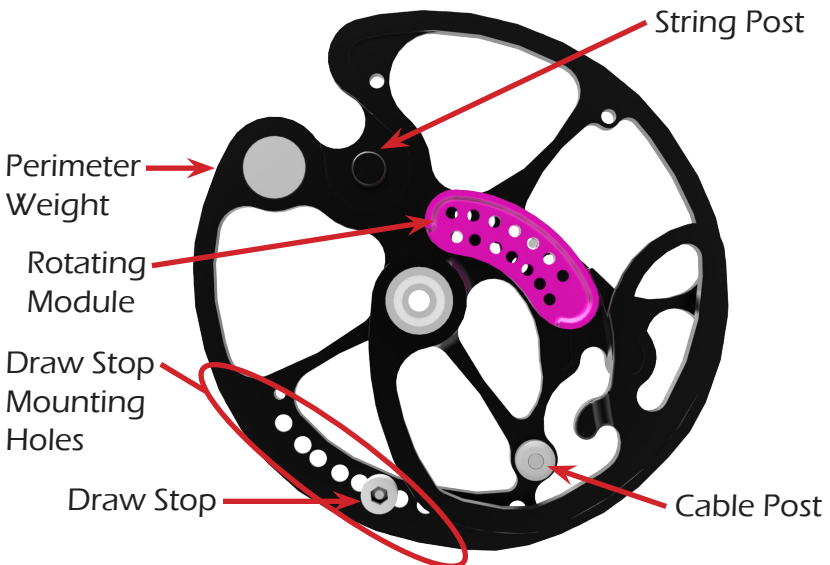

TOP CAM - Back View

INITIAL BOW SETUP

Before you can safely and effectively shoot your bow, a number of specific initial bow setup steps must be taken. These steps can be performed on your own, if your level of expertise is adequate. Or, your local Bear Archery dealer can help you.

Arrow Rest Installation & Setup

Arrow rests should be installed according to the manufacturer's specifications. The first adjustment you need to perform is setting the vertical height of your arrow rest. When properly adjusted, your arrow rest should align the centerline of the arrow with the center of the two holes used to mount the rest to the riser. To check this, place an arrow in the rest and nocked on the string. Visually confirm the center of the arrow passes directly through the center of the arrow rest mounting holes when viewed from the side. If not, adjust your rest up or down to correct.

Next, the rest should be adjusted for proper "Center shot". With an arrow in the rest and nocked on the string, firmly hold another arrow against the inside of the riser near the arrow rest mounting holes as illustrated. Look down the arrows and verify that the arrows are parallel to each other. In other words, the spacing between the two arrows should be the same along the entire length of the arrows. If not, adjust your rest side to side to correct. This is only your "initial" center shot and additional fine tuning may be required depending on your shooting style and equipment. Please refer to the images on the next page for further reference.

INITIAL BOW SETUP

Place arrow firmly against inside of riser shown.



Arrow rest should support the arrow in such a way that the arrow's centerline passes directly through the center of the two arrow rest mounting holes.

Arrows should be parallel along their entire length.



INITIAL BOW SETUP

Nocking Point and Nock Adjustment

Now that the initial center shot setting is complete, you need to verify your arrow nocking point. Install the nocking point or string loop on the bowstring so that when an arrow is nocked it creates a 90 degree angle to the string. Another option is to use a process similar to the one used to determine center shot. With an arrow in the rest and nocked on the string, firmly hold another arrow against the shelf of the riser as illustrated. Look down the arrows and verify that the arrows are parallel. In other words, the spacing between the two arrows should be the same along the entire length of the arrows. If not, adjust your nocking point up or down to correct.

At this time, adjust arrow fletch position to correspond with the arrow rest you are using. Such adjustments are done by simply rotating or replacing the arrow's nock. Carefully position the nock to provide proper fletch clearance through the arrow rest. Your local Bear Archery dealer can show you how to do this or can provide the service for you. Please refer to the images on the next page for further reference.

Install All Accessories

After your arrow rest and nocking point are installed correctly you will need to install all other accessories such as sights, quivers, silencers, peep sights, stabilizers, etc. Before mounting ANY accessories to the limbs, Refer to page 3 for important limb information.

INITIAL BOW SETUP Arrow Alignment



Place arrow firmly against shelf of riser as shown.



Arrows should be parallel along their entire length.



INITIAL BOW SETUP

Sight Adjustment

When first sighting in your new bow or bow sight, the key thing to remember is "Chase the arrows". In other words if your arrows are hitting the target to the right of the bull's-eye, move your sight to the right. If the arrows hit high on the target, raise your sight.

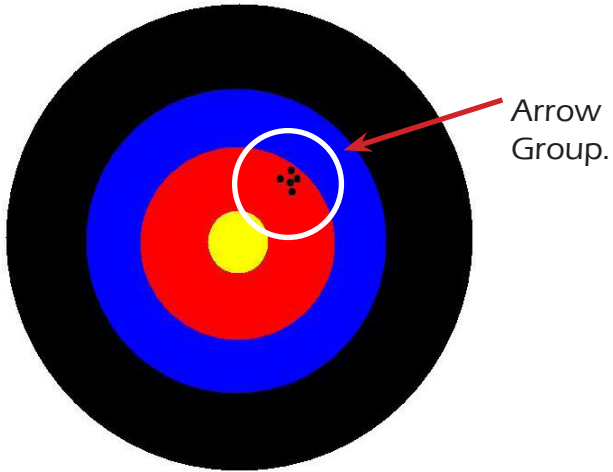

In the picture above, the arrows are hitting the target high and to the right of the bull's-eye. To correct this, adjust your sight up and to the right. Remember, "Chase the arrows."

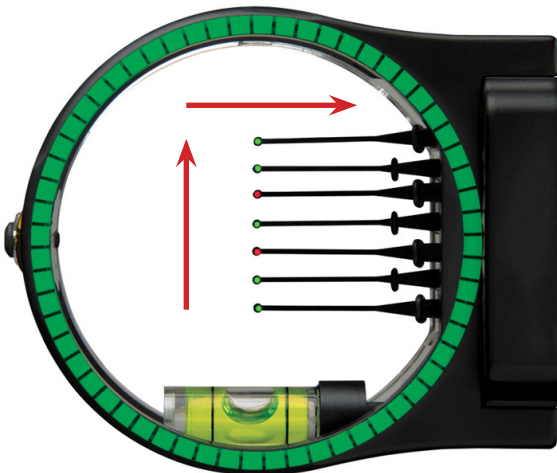

ARROW SELECTION

Arrow selection depends on the peak draw weight, let-off and draw length settings of your bow. Refer to arrow manufacturer's arrow selection tables using this information. The International Bowhunters Organization (IBO) allows a minimum of five grains arrow weight per pound of peak weight. Arrow weight is the total combined weight of your arrow nock insert, and point or broadhead. To determine the lightest arrow you can safely shoot, use the following format:

WARNING

Shooting arrows below these minimum weight requirements will void the warranty. Using arrows below five grains per pound of peak weight can approach dry-fire conditions and can severely reduce the life of your bow, and may cause serious injury. Contact your local Bear Archery pro shop or arrow manufacturers for arrow selection recommendations.

The weight of the arrow you select can be determined as follows:

1. From an arrow chart, find the weight of your arrow shaft based on the size and length.
2. Add the weight of your broadhead or point.
3. Add 35 grains to cover the nock, insert, and fletching. For example.

NOTE: It is always best to use a grain scale when available.

Bear Archery Warranty Statement

All Bear Archery compound bows are backed with a Limited Lifetime Warranty to the original owner. This warranty applies to limbs, risers, and cams. This warranty consists of the following programs:

Limbs: 100% covered at no charge for the first 5 years, 50% of replacement cost after.

- Risers: Lifetime Warranty.
- Cams: Lifetime Warranty.

Original Owner

Warranty applies only to the original owner and is not transferable. Proof of purchase may be required.

Items Not Covered

Cables, strings, bearings, paint and/or film dipped finishes resulting from normal wear and tear are not included in this warranty.

Damage Not Covered

Damage caused by abuse, mishandling, dry firing, alteration or modification made to original products are not covered under this warranty. The use of any bow press other than those approved by Bear Archery will void this warranty. Additionally, shooting of arrows less than 5 grains per pound of peak draw weight will void this warranty. Bear Archery reserves the right to make parts substitutions on warranty coverage at Bear Archery's sole discretion, for any reason.

Bow Warranty Registration

For this warranty to be in effect, the on-line warranty registration process must be completed at BearArcheryProducts.com and submitted within 30 days of purchase.

Bear Archery Warranty Statement Continued

Traditional Bows

1 year Limited Warranty to the original owner.

Youth Bows

90 Day Limited Warranty to the original owner.

In the event a bow requires warranty service, please contact the Bear Archery Customer Department at 800-694-9494 for a return authorization (RA) number and return shipping instructions. For full warranty details, please log on to BearArcheryProducts.com for further information.

Key Contact data

Dealer 800 Number: 800-694-9494

Dealer Fax Number: 812-467-1245

Web: www.BearArcheryProducts.com

©2013 Bear Archery

2L-7213-14