



We strive to ensure that our products are of the highest quality and free of manufacturing defects or missing parts. However, if you have any problems with your new product,

**DO NOT RETURN IT TO THE STORE,**

please contact us toll free @:

**1-888-996-2729**

**FAX: 1-866-873-3531**

**gameroom@escaladesports.com**

Or write to:

Escalade Sports

Customer Service Department

P.O. Box 889

Evansville IN 47706

Please visit our Web site at:

**[www.escaladesports.com](http://www.escaladesports.com)**

Please have your model number when inquiring about parts.

When contacting Escalade Sports please provide your model number, date code (if applicable) and part number if requesting a replacement part. These numbers are located on the product, packaging, and this owners manual.

Your Model Number AL3020W/F

Date Code 2 - AL3020W- - MW

Purchase Date \_\_\_\_\_

PLEASE RETAIN THIS INSTRUCTION MANUAL FOR FUTURE REFERENCE

**IMPORTANT! READ EACH STEP  
IN THIS MANUAL BEFORE YOU  
BEGIN THE ASSEMBLY.**

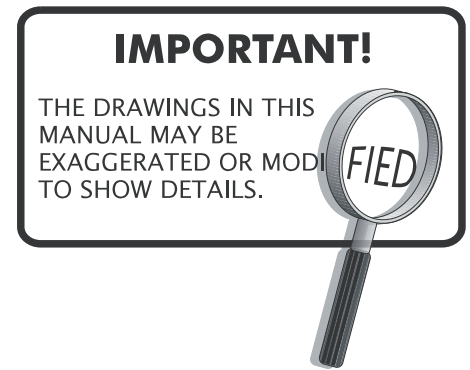

## TWO ADULTS ARE REQUIRED TO ASSEMBLE THIS 90" BROOKDALE BILLIARD TABLE

### Tools Required:

- Allen Wrench (included)
- Hex Wrench (included)
- Furniture Polish and Cloth
- Phillips Screw Driver

An electric screwdriver is helpful in assembly. However, please set at low torque and use extreme caution with an electric screwdriver because you could overtighten the hardware and strip the screws.

## Assembly Tips

Make sure you understand the following tips before you begin to assemble your billiard table.

1. Start all bolts by hand before tightening.
2. Some drawings or images in this manual may not look exactly like your product. Please read and understand the text before starting each assembly step.



**ATTENTION:**

**READ AND FOLLOW ALL ASSEMBLY, OPERATION, AND  
SAFETY INSTRUCTIONS CAREFULLY. AT LEAST TWO  
ADULTS ARE NEEDED TO ASSEMBLE THIS TABLE.**

# HARDWARE IDENTIFIER (To Scale)

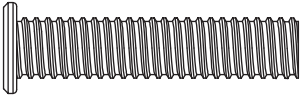

H1 - 5/16" x 1-1/2" Allen Head Bolt  
(12 pcs)

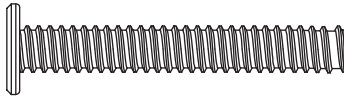

H2 - 1/4" x 1-3/4" Allen Head Bolt  
(26 pcs)



H3 - 4mm x 32mm Phillips Round Head Screw  
(16 pcs)

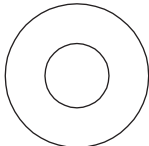

H4- 5/16" Flat Washer  
(12 pcs)

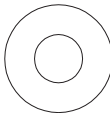

H5- 1/4" Flat Washer  
(36 pcs)



H6- 1/4" Hex Nut  
(10 pcs)



H7 - 5/16" Lock Washer  
(12 pcs)



H8 - 1/4" Lock Washer  
(26 pcs)

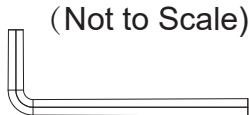

T1 - Allen Wrench  
(1 pc)

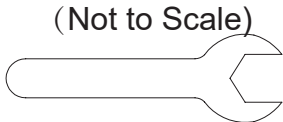

T2 - Hex Wrench  
(1 pc)  
(Used on H7 Hex Hut)

# PARTS IDENTIFIER (Not to Scale)

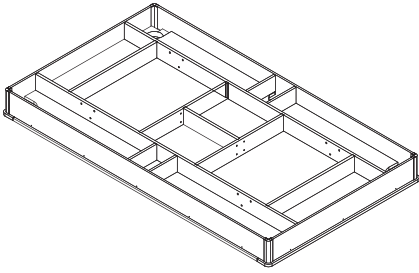

P1 - Main Cabinet  
(1 pc)

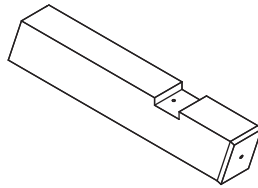

P2 - Leg A  
(2 pcs)

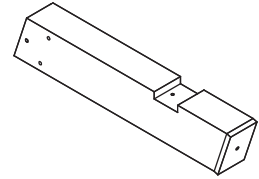

P3 - Leg B  
(2 pcs)

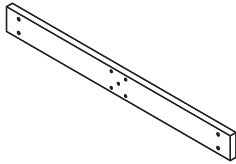

P4 - Leg Cross Support  
(2 pcs)

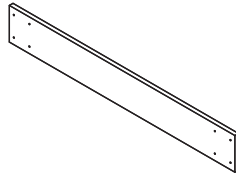

P5 - Leg Panel  
(2 pcs)

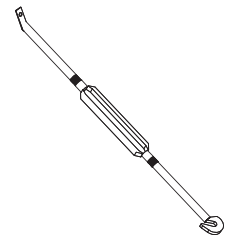

P6 - Turnbuckle Support  
(2 pcs)

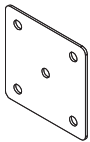

P7 - Leg Cross Support Plate  
(4 pcs)

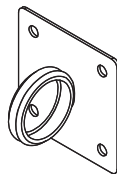

P8 - Cabinet Support Plate  
(2 pcs)

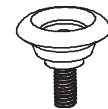

P9 - Leg Leveler  
(4 pcs)

Note: Will install onto P4 Leg  
Cross Supports

# ACCESSORIES IDENTIFIER (Not to Scale)

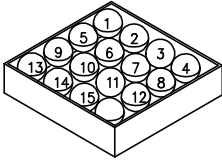

A1 - Billiard Ball Set  
(1 pc)

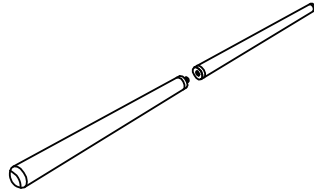

A2 -Pool Cue  
(2 pcs)

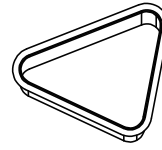

A3 - Triangle  
(1 pc)



A4 - Cue Chalk  
(2 pcs)

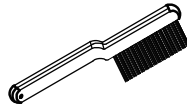

A5 - Playfield Brush  
(1 pc)

## PARTS REQUIRED

1pc - **P1** Main Cabinet  
2pcs - **P8** Cabinet Support Plate  
8pcs - **H2** Allen Head Bolt

8pcs - **H5** Flat Washer  
8pcs - **H8** Lock Washer

### STEP 1

Attach the **P8** Cabinet Support Plate onto the **P1** Main Cabinet Support Brace using the **H2** Allen Head Bolts, **H5** Flat Washers and **H8** Lock Washers as shown in **FIGURE 1**.

Tighten **H2** Allen Head Bolt using **T1** Allen Wrench.

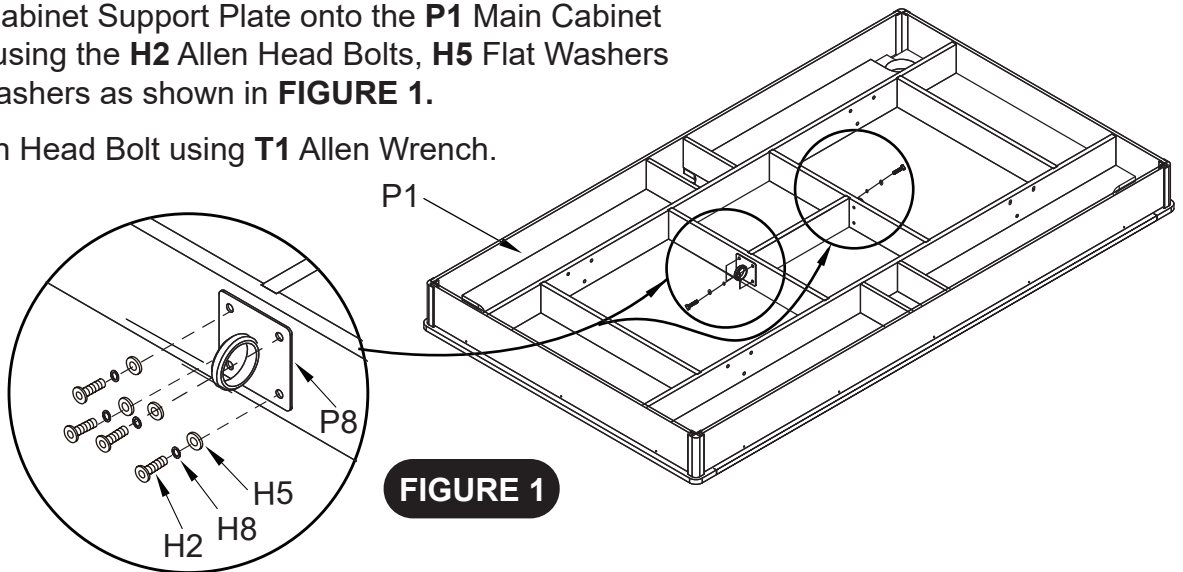

## PARTS REQUIRED

2pcs - **P2** Leg A  
2pcs - **P3** Leg B  
12pcs - **H1** Allen Head Bolt

12pcs - **H4** Flat Washer  
12pcs - **H7** Lock Washer

### STEP 2

Attach the **P2** Leg A, **P3** Leg B onto the **P1** Main Cabinet using the **H1** Allen Head Bolts, **H7** Lock Washers, **H4** Flat Washers as shown in **FIGURE 2**.

**Do not tighten H1 bolts, Snug tighten only.**

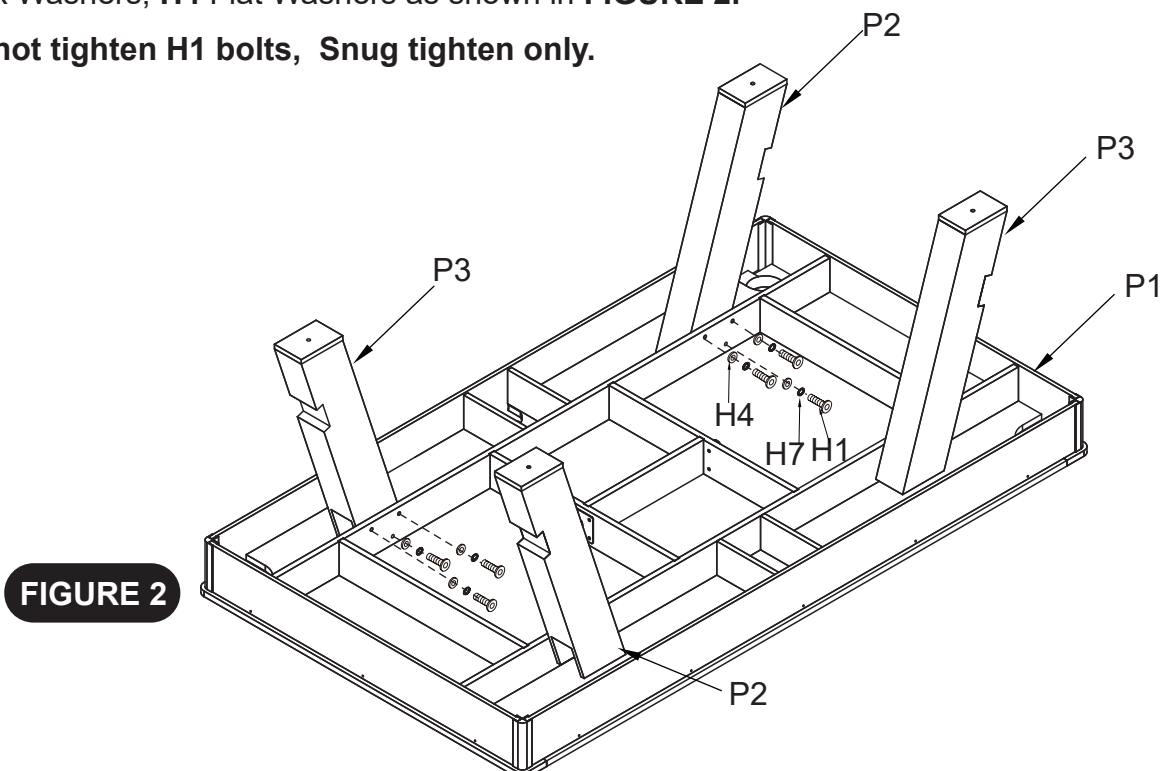

### PARTS REQUIRED

2pcs - **P4** Leg Cross Support  
 4pcs - **P7** Leg Cross Support Plate  
 8pcs - **H2** Allen Head Bolt

16pcs - **H5** Flat Washer  
 8pcs - **H6** Hex Nut  
 8pcs - **H8** Lock Washer

### STEP 3

Align the holes on the **P7** Leg Cross Support Plates with the predrilled holes on the **P4** Leg Cross Support. Attach the **P7** Leg Cross Support Plate onto the **P4** Leg Cross Support using the **H2** Allen Head Bolts, **H5** Flat Washers, **H8** Lock Washers, **H6** Hex Nuts as shown in **FIGURE 3**.

Tighten **H2** Bolts using **T1** Allen Wrench.  
 Tighten **H6** Hex Nut using **T2** Hex Wrench.

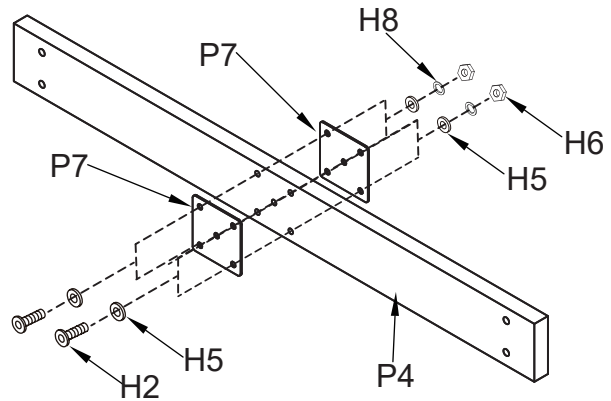

**FIGURE 3**

### PARTS REQUIRED

STEP 3 Assembly  
 8pcs - **H5** Flat Washer

8pcs - **H2** Allen Head Bolt  
 8pcs - **H8** Lock Washer

### STEP 4

Attach the STEP 3 Assembly to the **P2** Leg A and **P3** Leg B with the **H2** Allen Head Bolts, **H5** Flat Washers and **H8** Lock Washers as shown in **FIGURE 4**.

Tighten all leg bolts now using **T1** Allen Wrench---tight.

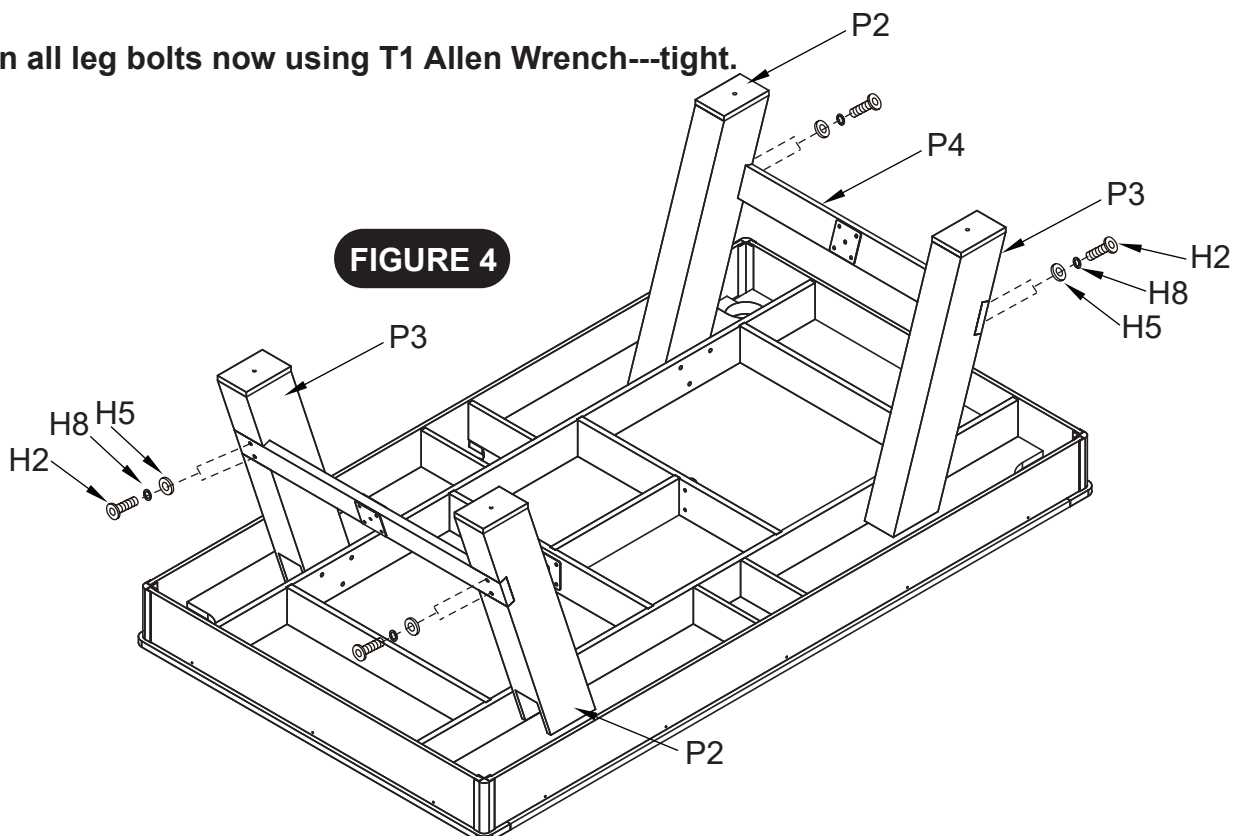

**FIGURE 4**

## PARTS REQUIRED

2pcs - **P6** Turnbuckle Support

4pcs - **P9** Leg Leveler

2pcs - **H2** Allen Head Bolt

4pcs - **H5** Flat Washer

2pcs - **H6** Hex Nut

2pcs - **H8** Lock Washer

### STEP 5

Attach the **P5** Turnbuckle Support onto the **P7** Leg Cross Support Plate using **H2** Allen Head Bolts, **H8** Lock Washers, **H5** Flat Washers and **H6** Hex Nuts as shown in **FIGURE 5**.

Tighten **H2** Allen Head Bolt using **T1** Allen Wrench.

Tighten **H6** Hex Nut using **T2** Hex Wrench.

Thread **P9** Leg levelers to legs as shown in **FIGURE 5**.

#### NOTE:

Do not tighten the turnbuckles, snug tighten only.

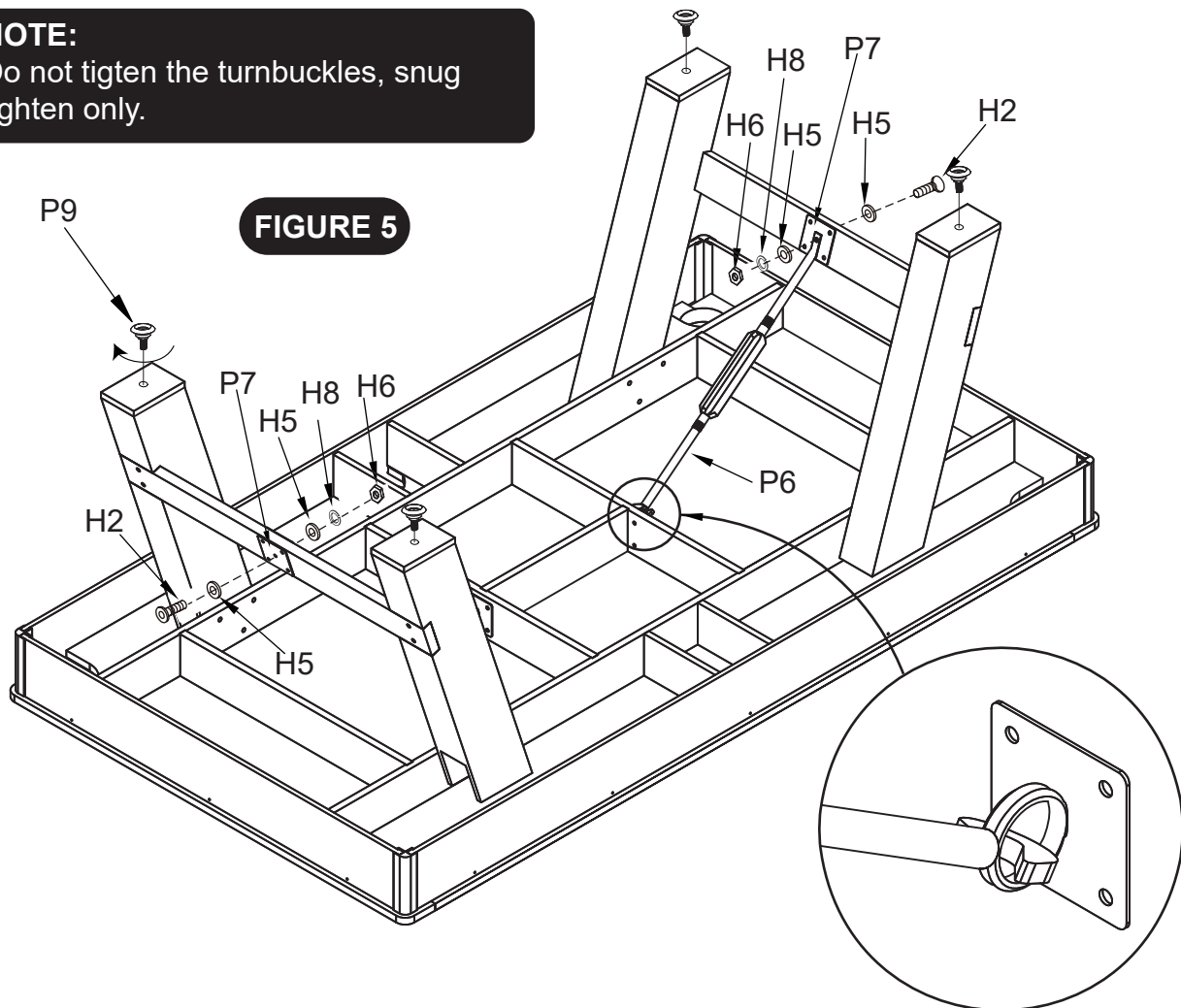



## PARTS REQUIRED

2pcs - **P5** Leg Panel

16pcs - **H4** Phillips Round Head Screw

### STEP 6

Attach the **P5** Leg Panel onto predrilled hole the **P2** Leg A and **P3** Leg B using **H4** Phillips Round Head Screws as shown in **FIGURE 6**.

Tighten **H4** Screws using the Phillips Screwdriver.

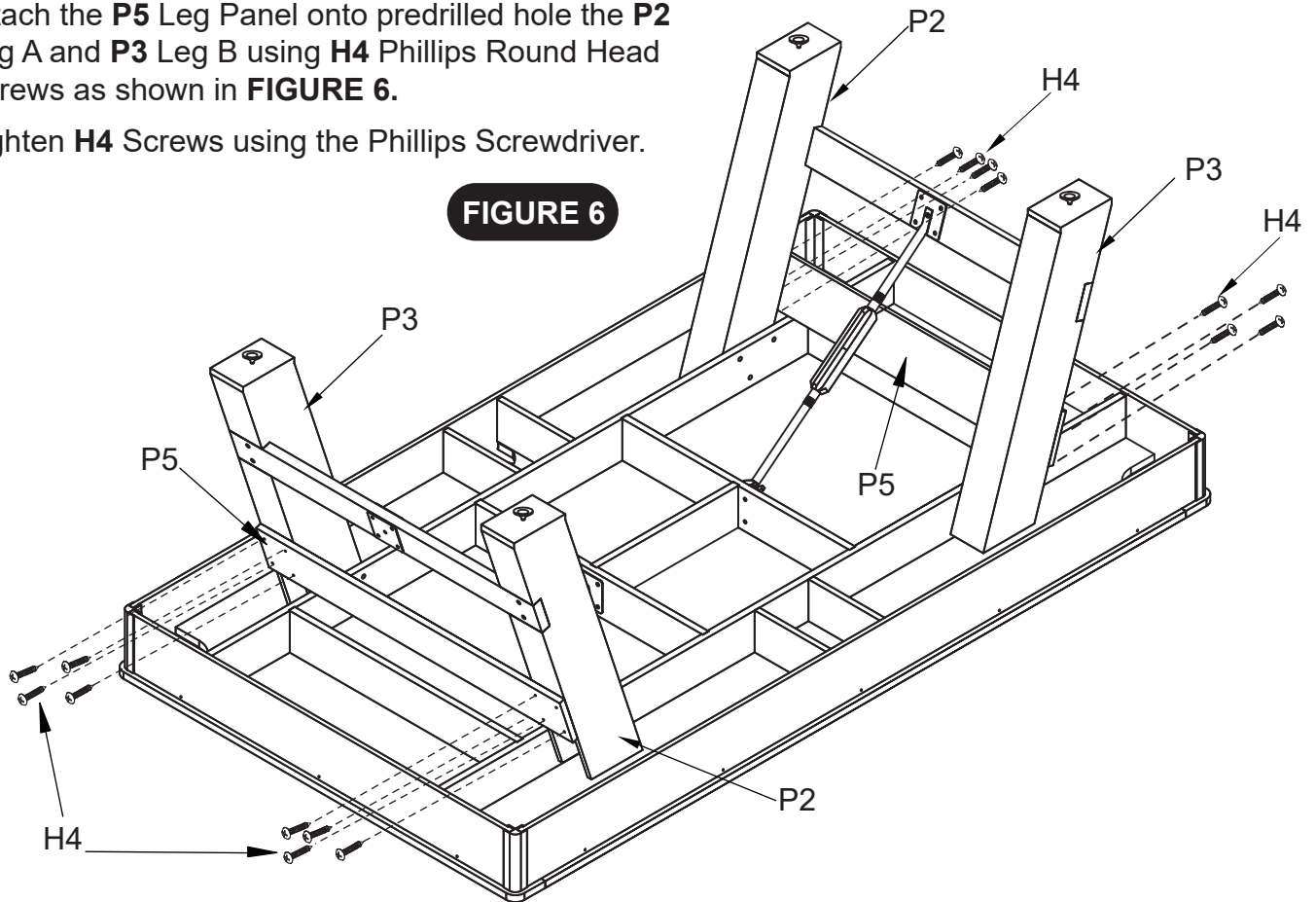

**FIGURE 6**

## **WARNING:**

**THIS STEP REQUIRES FOUR OR MORE ADULTS.**

**WHILE FLIPPING THE TABLE OVER, DO NOT ALLOW TABLE TO REST ON THE SIDE OF LEGS AS THIS COULD DAMAGE THEM.**

**VERY CAREFULLY TURN THE TABLE OVER AND SET IT ON ITS LEGS. BE CAREFUL. THE TABLE IS VERY HEAVY.**

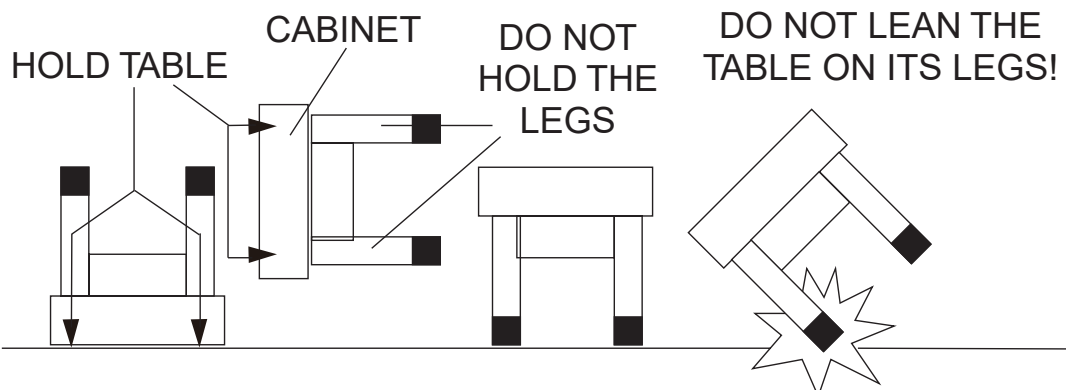

Congratulations! You have now assembled your table. Please note the Care and Use instructions below to insure many years of trouble free use of your game table.

### CARE AND USE OF YOUR TABLE

1. Use spray furniture polish to clean all exterior surfaces of your table.
2. Use the table brush provided to clean the cloth on the table.
3. This product is intended for **INDOOR** use only.
4. **DO NOT** sit, climb or lean on the table.
5. **DO NOT** drag the table when moving it. This will damage the legs.
6. **DO NOT** set drinks on the table.
7. The purchase of a table cover will both protect and help keep clean the entire top of the table.
8. Use a carpenters level to properly level the table using the leg levelers.

### PRODUCT PARTS LIST FOR MODEL # AL3020W/F

Key #	Part #	Description	Qty.
H1	AL3020MWH1	5/16" x 1-1/2" Allen Head Bolt	12
H2	AL3020MWH2	1/4" x 1-3/4" Allen Head Bolt	26
H3	AL3020MWH3	4mm x 32mm Phillips Round Head Screw	16
H4	AL3020MWH4	5/16" Flat Washer	12
H5	AL3020MWH5	1/4" Flat Washer	36
H6	AL3020MWH6	1/4" Hex Nut	10
H7	AL3020MWH7	5/16" Lock Washer	12
H8	AL3020MWH8	1/4" Lock Washer	26
T1	AL3020MWT1	Allen Wrench	1
T2	AL3020MWT1	Hex Wrench	1
P1	AL3020MWP1	Main Cabinet	1
P2	AL3020MWP2	Leg A	2
P3	AL3020MWP3	Leg B	2
P4	AL3020MWP4	Leg Cross Support	2
P5	AL3020MWP5	Leg Panel	2
P6	AL3020MWP6	Turnbuckle Support	4
P7	AL3020MWP7	Leg Cross Support Plate	2
P8	AL3020MWP8	Cabinet Support Plate	2
P9	AL3020MWP9	Leg Leveler	4
A1	AL3020MWA1	Billiard Ball Set	1
A2	AL3020MWA2	Pool Cue	2
A3	AL3020MWA3	Triangle	1
A4	AL3020MWA4	Cue Chalk	2
A5	AL3020MWA5	Playfield Brush	1
K1	AL3020MWK1	Hardware Kit	1
M1	AL3020MWM1	Owner's Manual	1

## 90 DAY LIMITED WARRANTY

This customer warranty extends to the original owner, on the purchase of any ESCALADE SPORTS Product (hereinafter referred as the "Product").

**WARRANTY DURATION:** This Product is warranted to the original owner, for a period of 90 days from the original purchase.

**WARRANTY COVERAGE:** ESCALADE SPORTS warrants to the original owner, this product to be free from defects in material and workmanship when used for the intended purpose under normal use and conditions. THIS WARRANTY IS VOID IF THE PRODUCT HAS BEEN DAMAGED BY ACCIDENT, UNREASONABLE USE, NEGLIGENCE, IMPROPER SERVICE, FAILURE TO FOLLOW INSTRUCTIONS PROVIDED WITH THE PRODUCT OR OTHER CAUSES NOT ARISING OUT OF DEFECTS IN MATERIAL AND WORKMANSHIP.

**WARRANTY REPLACEMENT:** During the above 90 day warranty period, ESCALADE SPORTS shall provide replacement components or replace with a comparable product at our choosing. If product is defective under normal use and proper care, please contact our Customer Service Dept.

1-888-996-2729 / Customer Service Dept.

Or Write us at:

Escalade® Sports, Inc. - P.O. Box 889, Evansville, IN 47706

Attn: Customer Service Dept.

Or E-mail us at:

[customerservice@escaladesports.com](mailto:customerservice@escaladesports.com)

Other than shipping requirements no charge will be made for such replacement of in-warranty Products.

**WARRANTY DISCLAIMERS:** ANY IMPLIED WARRANTIES ARISING OUT OF THIS SALE, INCLUDING BUT NOT LIMITED TO THE IMPLIED WARRANTIES OF MERCHANTABILITY AND FITNESS FOR A PARTICULAR PURPOSE, ARE LIMITED IN DURATION TO THE ABOVE 90 DAY PERIOD. ESCALADE SPORTS SHALL NOT BE LIABLE FOR LOSS OF USE OF THE PRODUCT OR OTHER CONSEQUENTIAL OR INCIDENTAL COSTS, EXPENSES OR DAMAGES INCURRED BY THE CONSUMER OF ANY OTHER USE.

Some states do not allow the exclusion or limitation of implied warranties or consequential or incidental damages, so the above limitations or exclusions may not apply to you.

**LEGAL REMEDIES:** This warranty gives you specific legal rights and you may also have other rights which may vary from state to state.